



- (51) International Patent Classification:  
A61N 1/08 (2006.01)
- (21) International Application Number:  
PCT/NZ2016/050182
- (22) International Filing Date:  
16 November 2016 (16.11.2016)
- (25) Filing Language: English
- (26) Publication Language: English
- (30) Priority Data:  
714212 16 November 2015 (16.11.2015) NZ
- (71) Applicant: UNIVERSITY OF WAIKATO [NZ/NZ];  
Hillcrest Road, Hamilton, 3216 (NZ).
- (72) Inventors: MCCABE, Steven Owen; 2a Paremata Cres-  
cent, Paremata, Porirua, 5024 (NZ). SCOTT, Jonathan  
Brereton; 26 Cranwell Place, Hillcrest, Hamilton, 3216  
(NZ).
- (74) Agents: MURPHY, Simon John et al.; Level 10, 21  
Queen Street, Auckland, 1010 (NZ).
- (81) Designated States (unless otherwise indicated, for every  
kind of national protection available): AE, AG, AL, AM,  
AO, AT, AU, AZ, BA, BB, BG, BH, BN, BR, BW, BY,  
BZ, CA, CH, CL, CN, CO, CR, CU, CZ, DE, DJ, DK, DM,  
DO, DZ, EC, EE, EG, ES, FI, GB, GD, GE, GH, GM, GT,  
HN, HR, HU, ID, IL, IN, IR, IS, JP, KE, KG, KN, KP, KR,  
KW, KZ, LA, LC, LK, LR, LS, LU, LY, MA, MD, ME,  
MG, MK, MN, MW, MX, MY, MZ, NA, NG, NI, NO, NZ,  
OM, PA, PE, PG, PH, PL, PT, QA, RO, RS, RU, RW, SA,  
SC, SD, SE, SG, SK, SL, SM, ST, SV, SY, TH, TJ, TM,  
TN, TR, TT, TZ, UA, UG, US, UZ, VC, VN, ZA, ZM,  
ZW.
- (84) Designated States (unless otherwise indicated, for every  
kind of regional protection available): ARIPO (BW, GH,  
GM, KE, LR, LS, MW, MZ, NA, RW, SD, SL, ST, SZ,  
TZ, UG, ZM, ZW), Eurasian (AM, AZ, BY, KG, KZ, RU,  
TJ, TM), European (AL, AT, BE, BG, CH, CY, CZ, DE,  
DK, EE, ES, FI, FR, GB, GR, HR, HU, IE, IS, IT, LT, LU,

[Continued on next page]

(54) Title: IMPLANT CONDUCTOR ASSEMBLY WITH IMPROVED RADIO FREQUENCY PROPERTIES

Figure 2

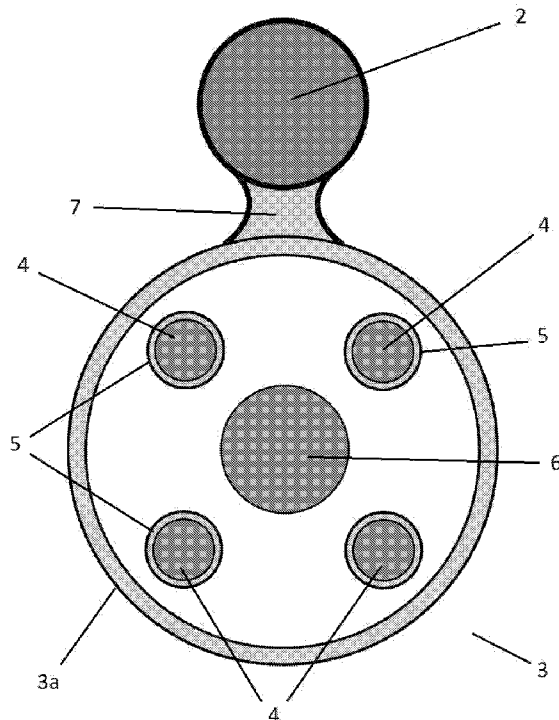

(57) Abstract: In one aspect the invention provides an im-  
plant conductor lead assembly which includes an electrode  
lead, and at least one field target conductor. The field target  
conductor(s) is located adjacent to the electrode lead to mu-  
tually couple the field target conductor to the electrode lead.  
The electrode lead acts to concentrate electromagnetic fields  
in the vicinity of the implant conductor assembly towards  
the field target conductor or conductors.

LV, MC, MK, MT, NL, NO, PL, PT, RO, RS, SE, SI, SK, SM, TR), OAPI (BF, BJ, CF, CG, CI, CM, GA, GN, GQ, GW, KM, ML, MR, NE, SN, TD, TG).

**Published:**

**Declarations under Rule 4.17:**

— of inventorship (Rule 4.17(iv))

— with international search report (Art. 21(3))

— before the expiration of the time limit for amending the claims and to be republished in the event of receipt of amendments (Rule 48.2(h))

## **IMPLANT CONDUCTOR ASSEMBLY WITH IMPROVED RADIO FREQUENCY PROPERTIES**

### **Field of the Invention**

5 This invention relates to an implant conductor assembly with improved radio frequency properties. Preferably the invention may be used to minimise the induction of radio frequency currents within an electrode lead of an implant conductor assembly.

### **10 Background of the Invention**

A variety of therapeutic devices have been developed to deliver bioelectrical stimulation therapies. These devices are surgically implanted into the body of a patient and normally incorporate control electronics connected to a power supply system such as a battery pack. As these components can be  
15 relatively large they may be sited within a user's body some distance from an organ, muscle or structure requiring bioelectrical stimulation. An implant electrode lead commonly needs to be run through the body from the power and control electronics to the region requiring bioelectrical stimulation.

20 Surgical implant manufacturers select implant conductors which exhibit low electrical resistance to direct currents. This selection minimises the voltage required to generate therapeutic currents while also maximising implant battery lifespans.

25 However, the presence of surgical implants creates a patient safety issue with the use of Magnetic Resonance Imaging (MRI) machines. The operation of MRI scanning machines involves:

- A large magnetic field,
- 30 • A varying magnetic field in the kilohertz range which induces eddy currents,
- An RF field operating at the 50-250 megahertz range.

5 MRI machines are carefully designed and used under strict operational protocols to avoid inadvertent heating of patient body tissues. The high frequency RF field can produce longitudinal electrode lead currents at RF frequencies which result in heating effects in the lead conductors and the electrodes.

10 Surgically implanted conductors act as antennas within the body and concentrate the strong radio frequency fields generated by an MRI machine. This can result in high temperatures at the electrode end of the implant as its lead is exposed to the MRI field. This is a significant patient safety problem when the length of the implant conductor is approximately equal to an odd integer multiple of the half wavelength at the electric field frequency – for example -  $\lambda/2$ ,  $3\lambda/2$ ,  $5\lambda/2$  etc.

15 One attempt to address these problems with implant leads and MRI machines is disclosed in United States Patent no. US 8364286. This document describes an implant lead assembly which employs a Faraday shield to surround and encapsulate an implant electrode lead. This technology aims to shield the electrode lead from local electromagnetic fields and thereby decrease the heating effects experienced by the lead.

20 However, the size and dimensions of implant conductor assemblies cause manufacturing complications for the technology described above. In particular, these forms of electrode lead shields must be formed on the same small scale as the electrode leads used and must fully enclose and wrap closely around the electrode lead to function effectively. These requirements therefore make the resulting implant conductor assembly difficult and expensive to manufacture.

30 It would therefore be of advantage to have available an improved implant conductor technology which addressed or mitigated the above problems, or at the very least provided an alternative choice over the current prior art. It would be of particular advantage to have an inexpensive implant conductor assembly with improved radio frequency properties targeted at minimising the induction of radio frequency currents within an implant conductor electrode lead.

## Disclosure of the Invention

5 According to one aspect of the present invention there is provided an implant conductor assembly which includes an electrode lead, and at least one field target conductor located adjacent to the electrode lead to mutually couple the field target conductor to the electrode lead, wherein the electrode lead acts to concentrate electromagnetic fields in the vicinity of the implant conductor assembly towards said at least one field target conductor.

10 According to a further aspect of the present invention there is provided an implant conductor assembly substantially as described above wherein said at least one field target conductor is positioned with its longitudinal axis parallel to the longitudinal axis of the electrode lead, the longitudinal axis of said at least one field target conductor and the electrode lead being offset from each other.

20 The present invention is arranged to provide an implant conductor assembly for use in combination with surgical implant technology, and will be referred to in various embodiments to as providing part of a surgical implant. Reference in general will also be made throughout this specification to this implant conductor assembly being used with a bioelectrical stimulation implant. In these applications an implant conductor assembly can include an electrode lead formed from a length of conductive material which has one end defining an electrode and an opposite end defining a supply terminal.

30 Those skilled in the art will however appreciate that the implant conductor assembly provided by the invention may be used in other applications if required. In particular the invention may be used with implants which need not necessarily provide a bioelectrical stimulation effect nor provide an implant conductor with one end forming an electrode or alternatively a supply terminal.

35 Furthermore the invention may potentially be used in combination with surgical implants installed in both humans and/or in animals. Those skilled in the art will appreciate that references made to implant technology does not restrict the use of the present invention to human recipients only.

Reference throughout this specification will also be made to an electrode lead provided with the invention being formed from an existing or prior art electrode lead. For example, in some embodiments an electrode lead may be formed from a structure which integrates a plurality of electrode conductors each being capable of performing as an electrode. In yet another embodiment an electrode lead may simply incorporate one such electrode conductor. The implant conductor assemblies provided by the invention incorporate one or more field target conductors to minimise or attenuate the induction of radio frequency electrical currents in such prior art electrode leads.

A field target conductor employed with the invention is located adjacent to the electrode lead at a position which promotes mutual coupling of the electrode lead to the field target conductor. The adjacent positioning of the field target conductor offsets the longitudinal axis of the electrode lead from the longitudinal axis of the field target conductor.

This may be contrasted with prior art implant conductor assemblies which employ a shield material wrapped around and enclosing an electrode conductor. With such prior art arrangements the longitudinal axis of the shield material is aligned with and therefore not offset from the longitudinal axis of the electrode lead. Conversely, with the present invention a field target conductor is positioned with its longitudinal axis parallel to the longitudinal axis of the electrode lead, each longitudinal axis being offset from the other.

The adjacent positioning of the field target conductor to the electrode lead and the mutual coupling of these elements results in the electrode lead concentrating electromagnetic fields in the vicinity of the assembly towards the field target conductor. The electrode lead – which normally experiences detrimental induced radio frequency currents – operates in the invention to direct and reflect electromagnetic fields so that field intensity is experienced by the field target conductor at the expense of the electrode lead. This effect is achieved by tailoring the size, length or dimensions of any field target conductor relative to the form of the electrode lead provided by the invention. In practice the assembly provided by the invention may be

described in terms of electromagnetic field antenna terminology, where the electrode lead acts as a mutually-coupled element with the field shaped towards the field target conductor after the fashion of 'reflector' and 'director' elements acting in a multi-element antenna.

5

In a preferred embodiment the length of a field target conductor may be less than the length of the electrode lead.

10

In some embodiments this length differential may be as small as half the wavelength of the expected electromagnetic field to which the assembly is to be exposed.

15

In various embodiments a range of field conductor lengths may be used. For example, in some embodiments a field target conductor can have a length in the range of 40% to 90% of the length of the electrode lead. In further embodiments a field target conductor may have a length in the range of 50% to 70% of the length of the electrode lead, while yet in other preferred embodiments a field target conductor can have a length approximately equal to 60% of the length of the electrode lead. Those skilled in the art will appreciate that the length of the field target conductor used can vary to suit the required performance of the invention, the type or types of MRI scanner machines the assembly is to be exposed to and potentially the materials used to construct the conductor.

20

25

Those skilled in the art will also appreciate that an implant conductor assembly provided by the invention may include only one field target conductor in some instances, while in other embodiments two or potentially more field target conductors may be provided adjacent to an electrode lead.

30

For example, in one embodiment a single field target conductor may be located adjacent to one side of an electrode lead, and may preferably extend approximately 60% of the length of the electrode lead.

35

In another embodiment a pair of field target conductors may be provided in conjunction with implant conductor lead assembly. In preferred embodiments of this form these two field target conductors can be located on opposite sides of the same electrode lead.

In such embodiments the pair of conductors can exhibit a range of lengths, and need not necessarily be of the same length. For example, in some instances these field target conductors may extend at least 40% of the length of the electrode lead, while in other embodiments they may exhibit lengths extending at least 60% of the length of the electrode lead. In yet other implementations one or both of this pair of field target conductors may extend approximately 90% of the length of the electrode lead.

Again those skilled in the art will appreciate that the length of the field target conductors used can vary to suit the required performance of the invention, the type or types of MRI scanner machines the assembly is to be exposed to and potentially the materials used to construct the conductor.

In yet other embodiments discrete linear arrays of relatively short field target conductors may be located adjacent to one side of an electrode lead, with multiple short conductors running the same length as an equivalent single long conductor. In further alternative embodiments multiple linear arrays of short field target conductors can be located on opposite sides of an electrode lead, with again the multiple short conductors running the same length as an equivalent single long conductor.

Furthermore, in additional embodiments a field target conductor may be optimised to perform effectively when exposed to the emissions of one specific type of MRI scanning machine, or a set of two or more types of MRI machines operating at different frequencies. For example, in some embodiments an implant conductor assembly may include a set of one or more field target conductors optimised to mitigate heating effects when exposed to the field of a 1.5 T / 64 MHz MRI scanner, and can also include a second set of one or more field target conductors optimised to mitigate heating effects when exposed to the field of a 3 T / 128 MHz MRI scanner. In yet other embodiments an implant conductor assembly may be provided with one or more field target conductors optimised to mitigate heating effects when exposed to the fields of both 1.5 T / 64 MHz and 3 T / 128 MHz MRI scanners.

A field target conductor may be formed from materials currently employed as existing prior art implant conductors. In various embodiments the conductive material selected may exhibit desirable electrical characteristics while minimising patient tissue rejection or irritation effects.

5

In preferred embodiments a field target conductor may be formed from a length of conductive material. This conductor will therefore have a longitudinal length dimension which is substantially greater than its cross-section width. The field target conductor will define an exterior surface which extends between each end of the length of conductive material.

10

Those skilled in the art will appreciate that various arrangements of conductive materials may be used to form lengths of field target conductor. In a range of embodiments a field target conductor may be formed by any arrangement of conductive components, such as a solid length of conductor, multi-stranded wire or alternatively woven conductive filaments or fibres. In various embodiments these filaments may have either a substantially solid or hollow cross section profile.

15

In a preferred embodiment a field target conductor may exhibit a substantially uniform transverse cross-section profile along its entire length. Reference throughout this specification will also be made to the field target conductor being provided with this uniform character, although those skilled in the art will appreciate that other arrangements and physical dimensions are also within the scope of the invention.

20

In a preferred embodiment at least a portion of the exterior surface of a field target conductor may be exposed to the body tissue of the recipient of the assembly.

25

For example, in one embodiment at least the mid-point or middle section of the length of the conductor is exposed to the body tissue of the implant recipient. Alternatively, in other embodiments substantially all of the exterior surface of the field target conductor may be exposed to the tissue of an implant recipient. However in yet other embodiments the ends of a field target conductor may be sealed inside an electrically insulating material.

30

In various embodiments the physical characteristics of the material used to provide a field target conductor may be optimised for its role as part of the surgical implant. In a preferred embodiment a field target conductor may be provided with an electrical resistance ranging from 10-100000 Ohms/meter.

5

In a preferred embodiment at least one field target conductor is formed of a material having increased electrical resistance such that the energy of an MRI field is dissipated substantially evenly throughout the at least one field target conductor.

10

For example, in various embodiments the material used to form such a conductor may be selected for relatively high electrical resistance – such as that provided by low conductivity metals or various composite materials – which are still able to perform effectively as field target conductors. An increased electrical resistance allows the energy of an MRI field directed into a target field conductor to be dissipated evenly throughout its length as heat at temperatures which are unlikely to damage body tissues. A range of materials may be used in various embodiments to provide such electrical resistance improvements, including – but not limited to – gold, platinum, iridium, rhodium and their alloys, as well as silver cored wires, titanium, tungsten and/or stainless steel.

15

20

In yet other embodiments the physical structure and/or electrical connections made by a field target conductor may be optimised to maximise the effective surface area of the conductor. In such embodiments it is preferable to maximise the exposure of the surface of a field target conductor to the tissue of an implant patient. Surface area increases improve the electrical coupling experienced between the field target conductor and these tissues, allowing energy absorbed by the target conductor to be dissipated into the surrounding patient tissues. Surface area increases may be produced by selecting a broad diameter target field conductor, roughening the surface of such a conductor, or potentially in some instances by connecting the end of the conductor furthest from the electrode of the implant to other internal implant components, such as an impulse generator housing.

25

30

35

The present invention may therefore provide potential advantages over the prior art or at least provide an alternative choice to the existing prior art.

5 The invention adds at least one field target conductor to various forms of prior art implant electrode leads. The addition of a field target conductor therefore improves the resulting implant assembly without requiring any significant modifications to these prior art implant electrode leads.

10 The invention can be used to mitigate the health risks associated with the exposure of surgical implants to strong electromagnetic fields. The implant conductor assembly provided by the invention can minimise the induction of radio frequency currents within an implant conductor electrode lead.

15 The implant conductor assembly provided by the invention may be used with a wide variety of prior art implant conductor materials and may also provide safety advantages over a range of frequencies of alternating current. In particular the invention may safeguard surgical implant users from tissue heating and induced current effects in various situations ranging from exposure to MRI machines through to, for example, proximity to electrical  
20 welding machines or strong electromagnetic signal transmitters.

### **Brief description of the drawings**

25 Additional and further aspects of the present invention will be apparent to the reader from the following description of embodiments, given by way of example only, with reference to the accompanying drawings in which:

- 30 • Figure 1 provides a perspective view of one end of an implant lead assembly with a single field target conductor as provided in accordance with one embodiment of the invention.
- Figure 2 provides a side cross section view through the assembly of figure 1 where marked at line A-A.

35

- 5       • Figures 3a, b and c show midpoint cross-section views of the simulated magnitude of the magnetic field surrounding an insulated conductor in figure 3a, an electrode wire lead with single field target conductor in figure 3b, and an electrode wire lead flanked by two opposed field target conductors in figure 3c.
  
- 10       • Figure 4 provides a perspective view of one end of an implant lead assembly with multiple field target conductors as provided in accordance with an alternative embodiment to that shown with respect to figures 1 and 2.
  
- 15       • Figures 5a, 5b show heat generated plotted against various lengths of the lead when a single field target conductor is provided. Figure 5a shows temperature changes experienced at the distal electrode of the electrode lead when the electrode lead is adjacent to this single field target conductor. Figure 5b shows temperature changes experienced in the single field target conductor located adjacent to an electrode lead.
  
- 20       • Figures 6a, 6b show heat generated plotted against various lengths of the lead when the electrode lead is adjacent to two opposed field target conductors. Figure 6a shows temperature changes experienced at the distal electrode of the electrode lead when the electrode lead is adjacent to these two opposed field target conductors. Figure 6b  
25       shows heat generated by one of the two field target conductors when the electrode lead is adjacent to these two opposed field target conductors.
  
- 30       • Figures 7a, 7b show the temperature change of the distal electrode plotted against length of the electrode lead in the case of the single field target conductor arrangement of figure 5a.

- Figures 8a, 8b show the temperature change of the distal electrode plotted against length of the electrode lead in the case of the dual field target conductor arrangement of figure 6a.
- 5 • Figure 9 shows a comparison of simulated predictions of heat generated at the distal electrode plotted against various lengths of the lead with differing diameter measurements.

10 Further aspects of the invention will become apparent from the following description of the invention which is given by way of example only of particular embodiments.

### **Best modes for carrying out the invention**

15 Figure 1 provides a perspective view of one end of an implant lead assembly 1 which incorporates a single field target conductor 2 in accordance with one embodiment of the invention. Figure 2 provides a side cross section view through the assembly 1 where marked at line A-A.

20 The implant conductor assembly 1 includes an electrode lead 3, and the single field target conductor 2 shown. The field target conductor 2 is located adjacent to the electrode lead 3 to mutually couple the field target conductor to the electrode lead. Surface portions 3a of the exterior of the electrode  
25 lead are coated in an electrical insulation jacket material, while exposed surface portions 3b form contact electrodes.

As can be seen from figure 2 the field target conductor 2 is formed from a solid length of conductive metal wire. The electrode lead shown incorporates  
30 four electrode conductors 4 surrounded by the jacket of electrical insulator material 3a which retains each electrode conductor in place within the electrode lead structure. These conductors 4 are able to move to a limited degree inside the insulator jacket 3a. Each of the four electrode conductors are also coated with a layer of insulation 5. A stylet 6 is provided to guide  
35 the entire assembly into the body of a recipient. Once the assembly is

installed within a user the stylet is removed leaving a void in the interior of the electrode lead 3.

5 The field target conductor 2 is located to one side of the electrode conductor, thereby providing a parallel offset orientation to the longitudinal axes of each of the field target conductor 2 and electrode lead 3. A layer of adhesive 7 is used to locate the field target conductor 2 with its longitudinal axis parallel to the longitudinal axis of the electrode lead 3, where the longitudinal axis of each of the field target conductor and electrode lead are  
10 offset from each other.

This positioning of the electrode lead 3 and the relative lengths of each conductor act to concentrate electromagnetic fields in the vicinity of the assembly 1 towards the field target conductor 2. This interaction between  
15 the field target conductor and electrode lead is shown in more detail with respect to figures 3a and 3b.

Figures 3a, b and c show midpoint cross-section views of the simulated magnitude of the magnetic field surrounding an insulated electrode lead in  
20 figure 3a, an insulated electrode lead with single field target conductor in figure 3b and an insulated electrode lead flanked by two opposed field target conductors in figure 3c. In each of these plots the total length,  $l$ , of the insulated electrode lead is 25 cm. Figure 3b shows an insulated electrode lead with a single bare conductor 60% the length of the lead, while figure 3c  
25 shows two target field conductors which are 90% the length of the insulated electrode lead depicted.

Figure 3a shows the magnetic field distribution for the electrode lead 3 in the absence of a field target conductor. As can be seen by this image the lead 3  
30 acts as an antenna to concentrate the field intensity about the longitudinal axis of the lead.

Figure 3b shows the distribution of the same magnetic field when the field target conductor is located adjacent to the electrode lead. As can be seen  
35 from figure 3b the field has been shaped by the combination with the adjacent conductor, with the field target conductor experiencing the areas of highest intensity when compared to that experienced by the electrode lead.

Figure 3c shows the distribution of the same magnetic field when a pair of opposed field target conductors are located on opposite sides of the electrode lead. As can again be seen from figure 3c the field has been shaped by the combination of adjacent conductors, with the field target conductors experiencing the areas of highest intensity when compared to that experienced by the electrode lead.

Figure 4 provides a perspective view of one end of an implant lead assembly 11 with multiple field target conductors 12 provided in an alternative embodiment to that shown with respect to figures 1 and 2. The magnetic fields experienced by this form of assembly are discussed with respect to figure 3c.

This alternative arrangement positions a pair of opposed field target conductors on either side of an electrode lead 13. The ends of each field target conductor are encapsulated by a plastic insulator material while the middle section of each conductor (not shown) is exposed to the body tissue of the recipient of the assembly.

In this embodiment each field target conductor has a length approximately 90% that of the electrode lead, allowing the electrode lead to shape and reflect electromagnetic fields towards each field target conductor.

Figures 5a, 5b show heat generated at the distal electrode plotted against various lengths of the lead when a single field target conductor is provided. Figure 5a shows temperature changes experienced at the distal electrode of the electrode lead when the electrode lead is adjacent to this single field target conductor. Figure 5b shows temperature changes experienced in the single field target conductor located adjacent to the electrode lead.

Field target conductor lengths are varied from 0.3– 0.9 l to produce the data plotted, where a standard lead without a field target conductor has the profile denoted by “none”.

Fig. 5(a) shows simulated predictions of the distal heating for an assortment of electrode leads with length l, each having a single field target conductor of

specified fraction of this length. It is apparent a field target conductor of length 0.6l–0.7l produces the least amount of heating over the range.

5 The field target conductor itself experiences some heating along its length as is shown in Fig. 5(b).

10 Figures 6a, 6b show heat generated plotted against various lengths of the lead when the electrode lead is adjacent to two opposed field target conductors. Figure 6a shows temperature changes experienced at the distal electrode of the electrode lead when the electrode lead is adjacent to these two opposed field target conductors. Figure 6b shows heat generated by one of the two field target conductors when the electrode lead is adjacent to these two opposed field target conductors.

15 Field target conductor lengths are varied from 0.3– 0.9l to produce the data plotted, where a standard lead without a field target conductor has the profile denoted by “none”. Distal heating is virtually eliminated for leads with two field target conductors as is shown Fig. 6(a), when the length of each equivalent field target conductor is between 0.7l–0.9.

20 Figures 7a, 7b show the temperature change of the distal electrode plotted against length of the electrode lead in the case of the single field target conductor arrangement of figure 5a. The measured distal heating of electrode leads with a single 0.6l target conductor and a 0.9l target conductor are shown in Figs. 7(a) and 7(b), respectively.

30 Figures 8a, 8b show the temperature change of the distal electrode plotted against length of the electrode lead in the case of the dual field target conductor arrangement of figure 6a. The measured distal heating of electrode leads with a 0.6l target conductor and a 0.9l target conductor are shown in Figs. 8(a) and 8(b), respectively.

35 Fig. 8 shows an even greater reduction in distal heating when the same leads have a pair of opposed (and possibly identical) field target conductors.

Figure 9 shows a comparison of simulated predictions of heat generated at the distal electrode plotted against various lengths of the lead with differing

diameter measurements. This figure illustrates embodiments which include a single field target conductor with a length of either 0.6l or 0.9l. The dashed line traces illustrate the heat increase for target conductors with diameters of 0.4mm, whereas the thicker variants have diameters of 0.8mm. As shown, the field target conductors with the larger diameters result in less distal heating.

It is to be understood that the present invention is not limited to the embodiments described herein and further and additional embodiments within the spirit and scope of the invention will be apparent to the skilled reader from the examples illustrated with reference to the drawings. In particular, the invention may reside in any combination of features described herein, or may reside in alternative embodiments or combinations of these features with known equivalents to given features. Modifications and variations of the example embodiments of the invention discussed above will be apparent to those skilled in the art and may be made without departure of the scope of the invention as defined in the appended claims.

**What we claim is:**

- 5 1. An implant conductor lead assembly which includes an electrode lead, and at least one field target conductor located adjacent to the electrode lead to mutually couple the field target conductor to the electrode lead,  
10 wherein the electrode lead acts to concentrate electromagnetic fields in the vicinity of the implant conductor assembly towards said at least one field target conductor.
- 15 2. An implant conductor lead assembly as claimed in claim 1 wherein at least one field target conductor is positioned with its longitudinal axis parallel to the longitudinal axis of the electrode lead, the longitudinal axis of said at least one field target conductor and the electrode lead being offset from each other.
- 20 3. An implant conductor lead assembly as claimed in claim 1 as provided as part of a surgical implant.
- 25 4. An implant conductor lead assembly as claimed in claim 1 wherein the field target conductor is formed from a solid length of conductor material.
- 30 5. An implant conductor lead assembly as claimed in claim 1 wherein the field target conductor is formed from multi-stranded wire.
6. An implant conductor lead assembly as claimed in claim 1 wherein the length of a field target conductor is less than the length of the electrode lead.
- 35 7. An implant conductor lead assembly as claimed in claim 6 wherein the length difference is half the wavelength of the expected electromagnetic field of an MRI machine.

8. An implant conductor lead assembly as claimed in claim 6 wherein a field target conductor has a length in the range of 40% to 90% of the length of the electrode lead.
- 5 9. An implant conductor lead assembly as claimed in claim 8 wherein a field target conductor has a length in the range of 50% to 70% of the length of the electrode lead.
- 10 10. An implant conductor lead assembly as claimed in claim 9 wherein a field target conductor has a length approximately equal to 60% of the length of the electrode lead.
- 15 11. An implant conductor lead assembly as claimed in claim 10 which includes a single field target conductor located adjacent to one side of the electrode lead and extending approximately 60% of the length of the electrode lead.
- 20 12. An implant conductor lead assembly as claimed in claim 6 which includes a pair of field target conductors.
- 25 13. An implant conductor lead assembly as claimed in claim 12 wherein the field target conductors are located on opposite sides of the electrode lead.
- 30 14. An implant conductor lead assembly as claimed in claim 12 or claim 13, wherein the field target conductors each extend at least 40% of the length of the electrode lead.
- 35 15. An implant conductor lead assembly as claimed in claim 14 wherein the field target conductors each extend at least 60% of the length of the electrode lead.
16. An implant conductor lead assembly as claimed in claim 15 wherein the field target conductors each extend approximately 90% of the length of the electrode lead.

- 5
17. An implant conductor lead assembly as claimed in claim 1 wherein at least one field target conductor is formed of a material having increased electrical resistance such that the energy of an MRI field is dissipated substantially evenly throughout the at least one field target conductor.
18. An implant conductor lead assembly as claimed in claim 1 which exhibits an electrical resistance ranging from 10-100000 Ohms/meter.
- 10 19. An implant conductor lead assembly as claimed in claim 1 wherein the ends of a field target conductor are sealed inside an electrically insulating material.
- 15 20. An implant conductor lead assembly as claimed in claim 1 wherein at least a portion of the exterior surface of a field target conductor is exposed to the body tissue of the recipient of the assembly.
- 20 21. An implant conductor lead assembly as claimed in claim 20 wherein substantially all of the exterior surface of the field target conductor is exposed to the tissue of an implant recipient.
- 25 22. An implant conductor lead assembly as claimed in claim 20 wherein at least the mid-point of the length of the conductor is exposed to the body tissue of the implant recipient.

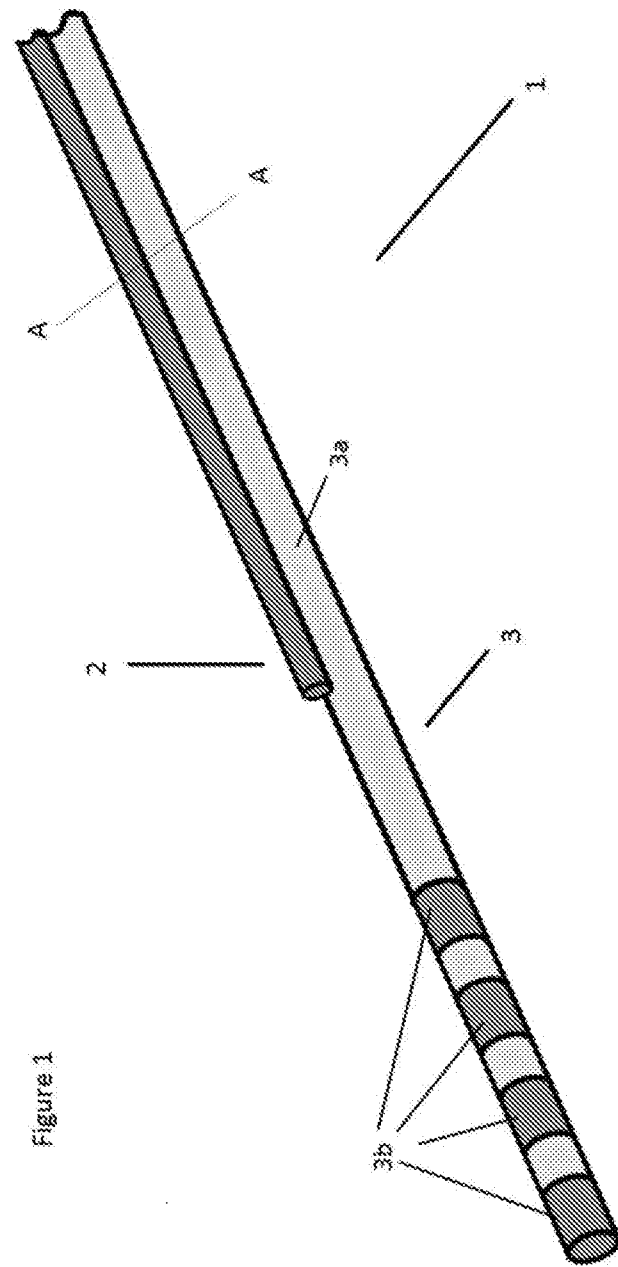
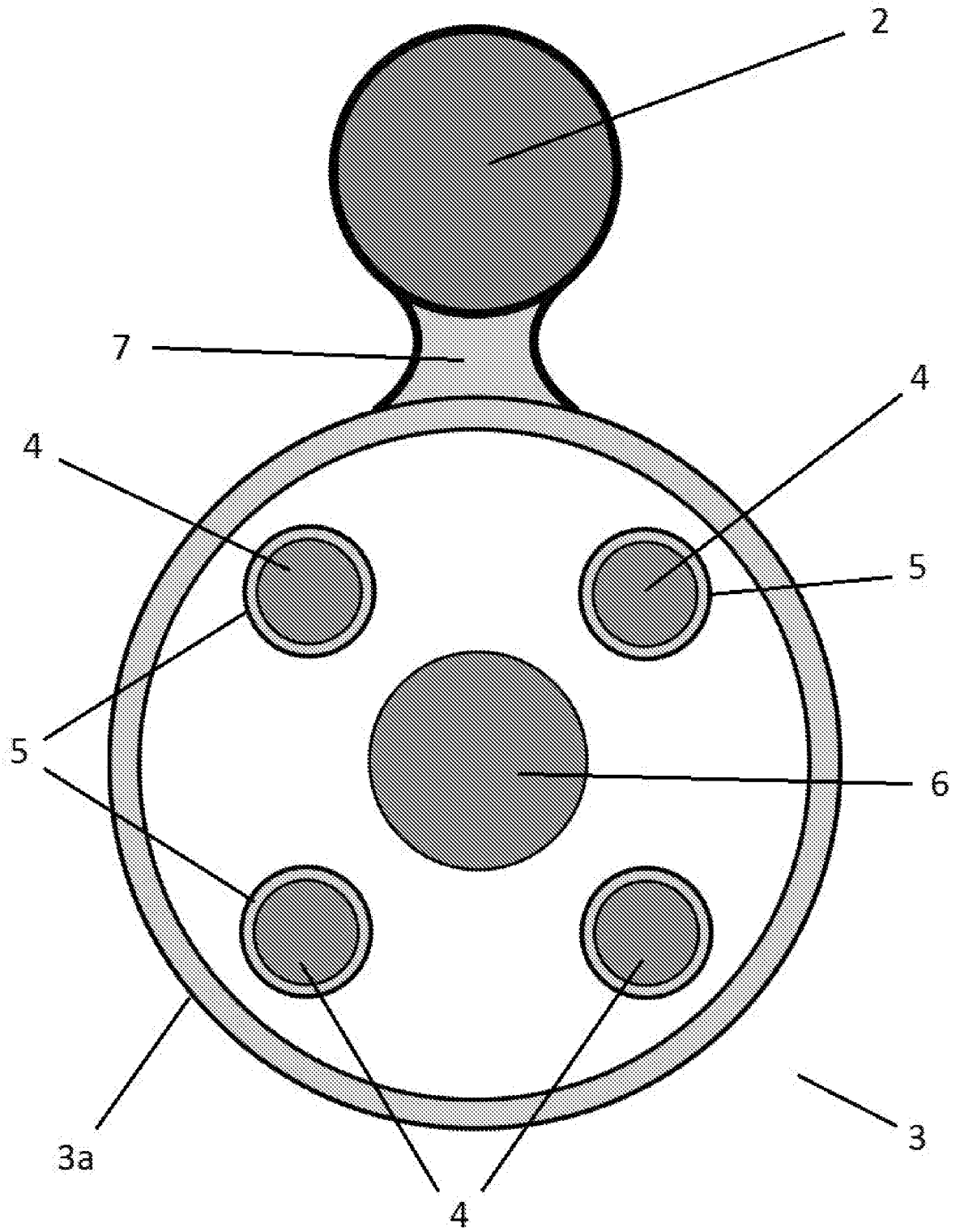

Figure 1

Figure 2



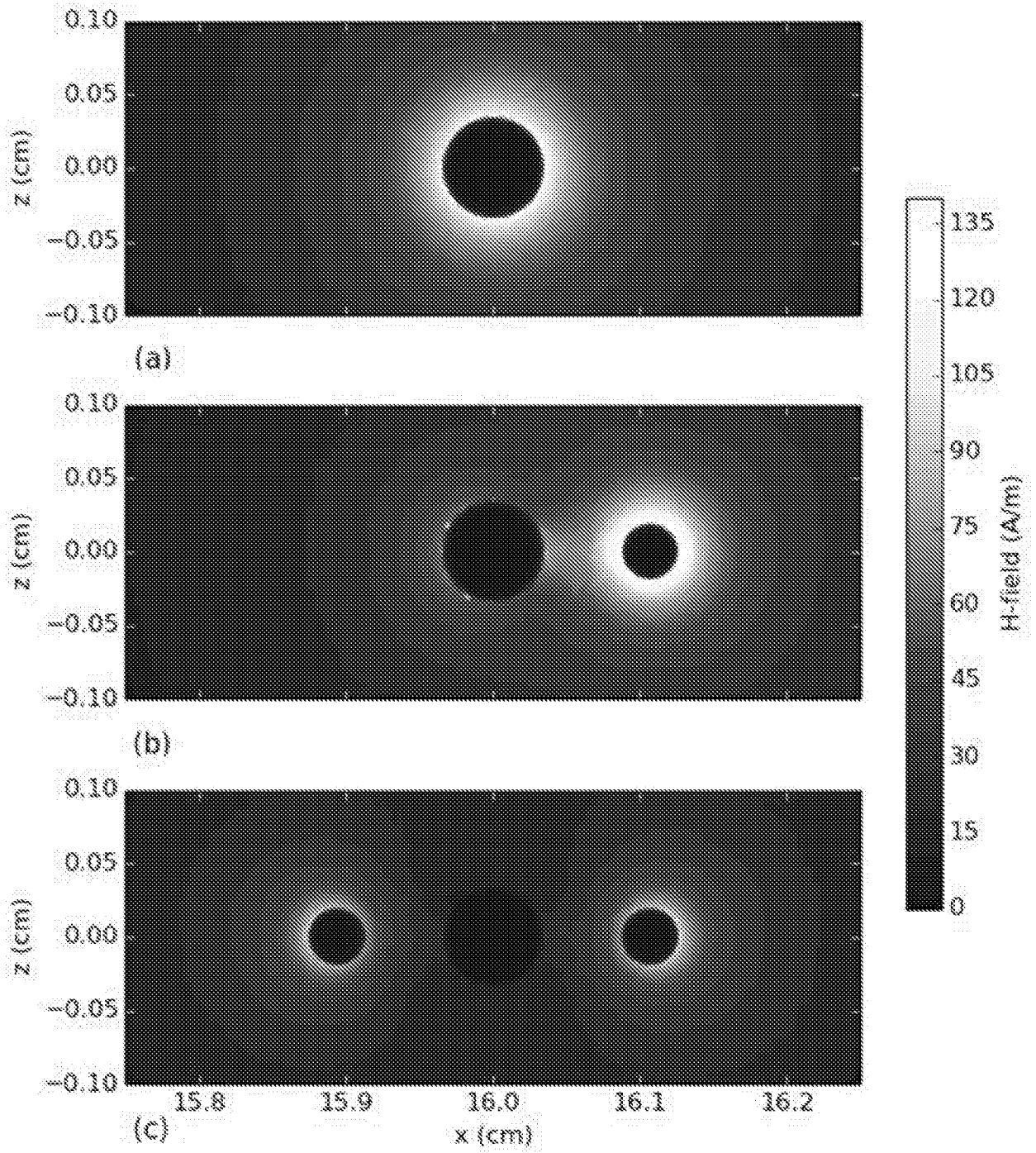

Figure 3

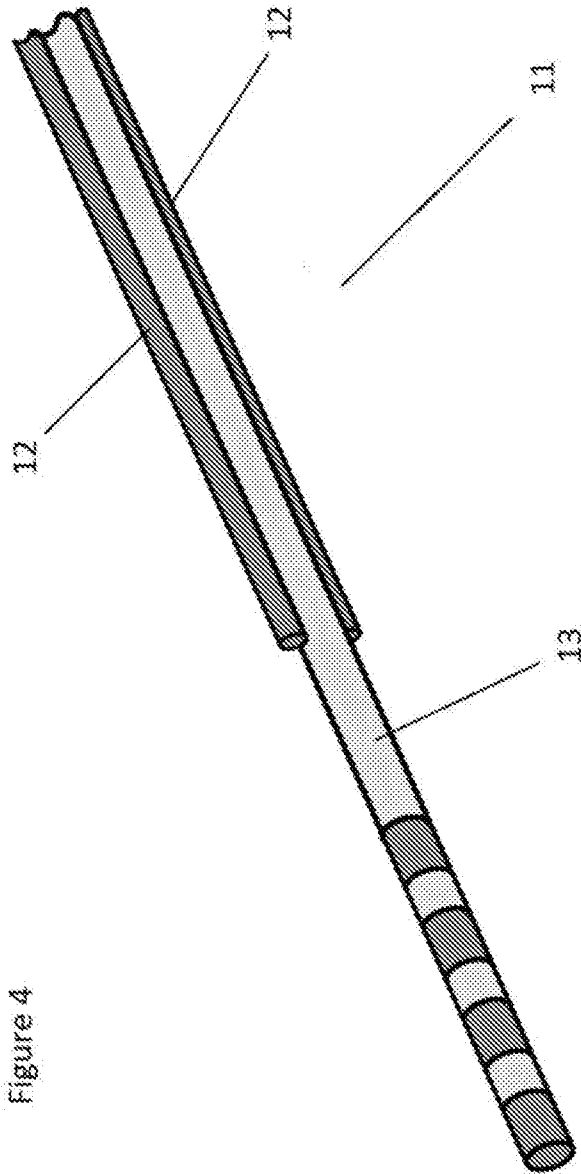

Figure 4

Figure 5a

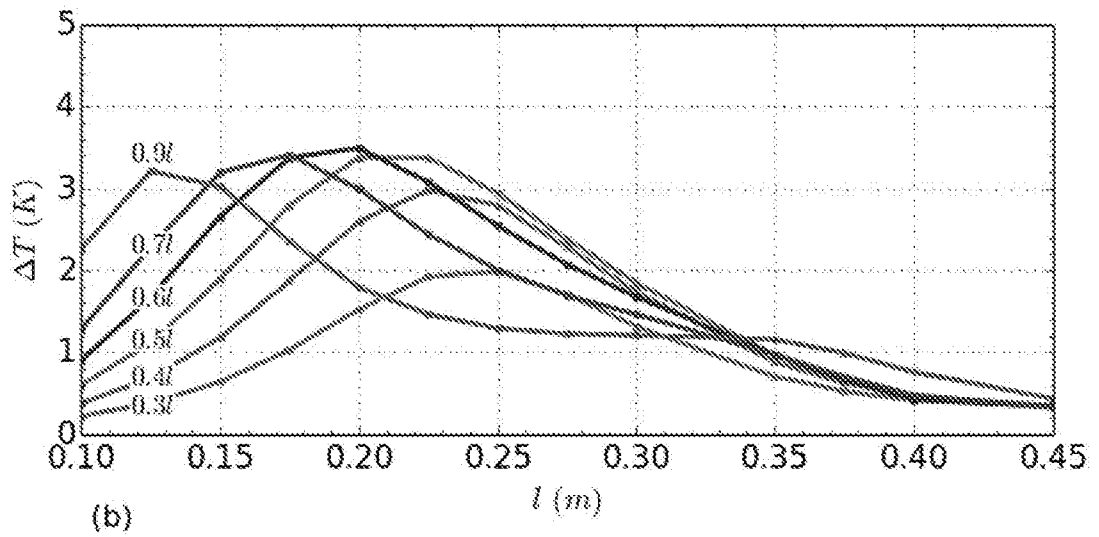
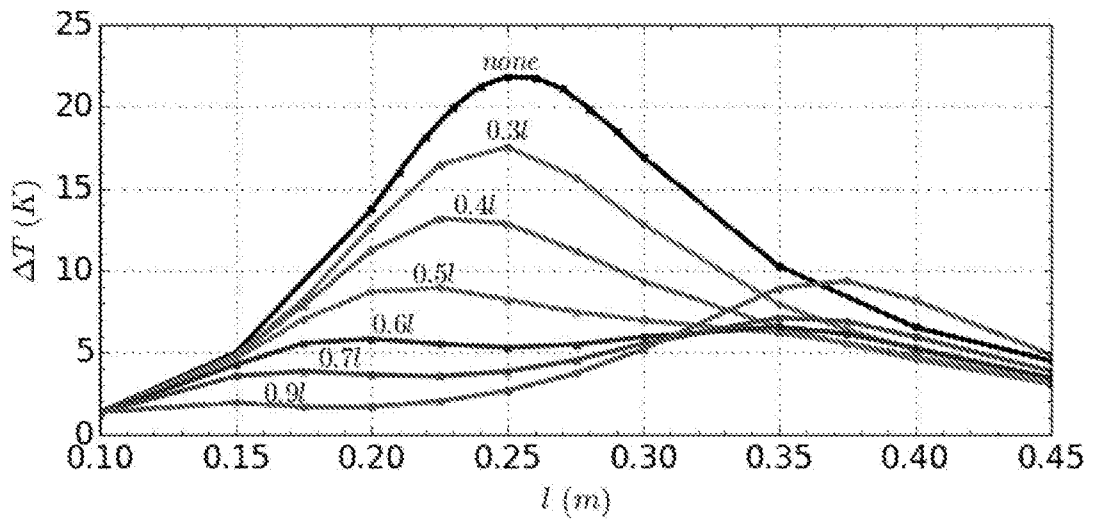

Figure 5b

Figure 6a

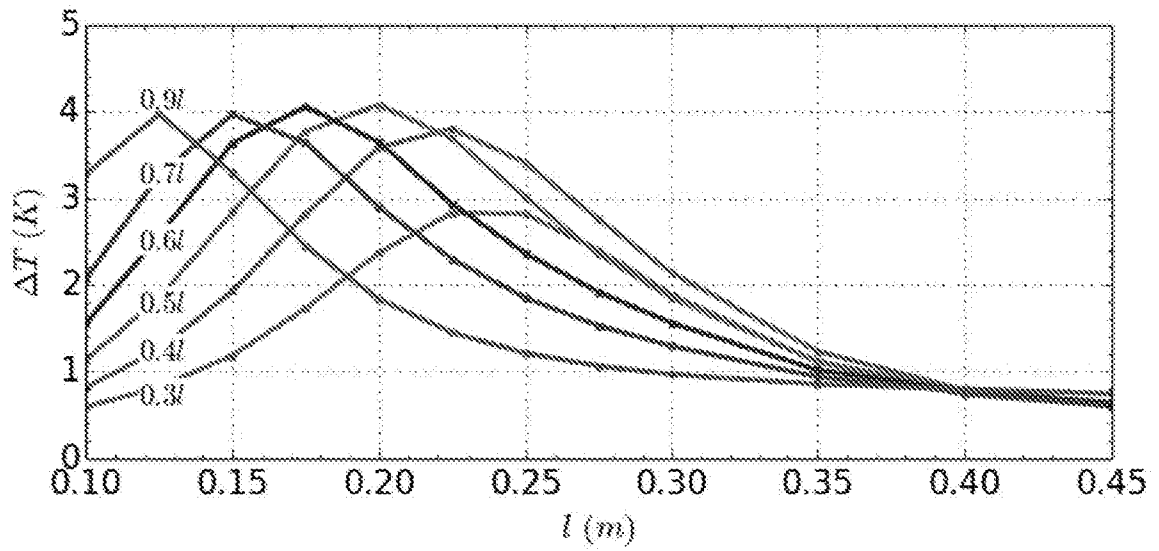
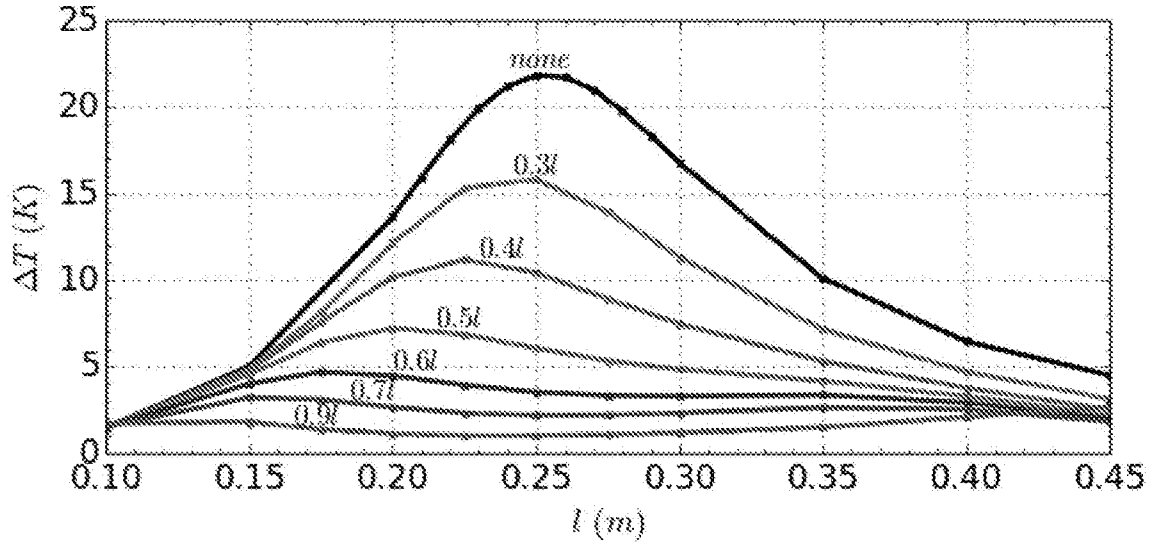

Figure 6b

Figure 7a

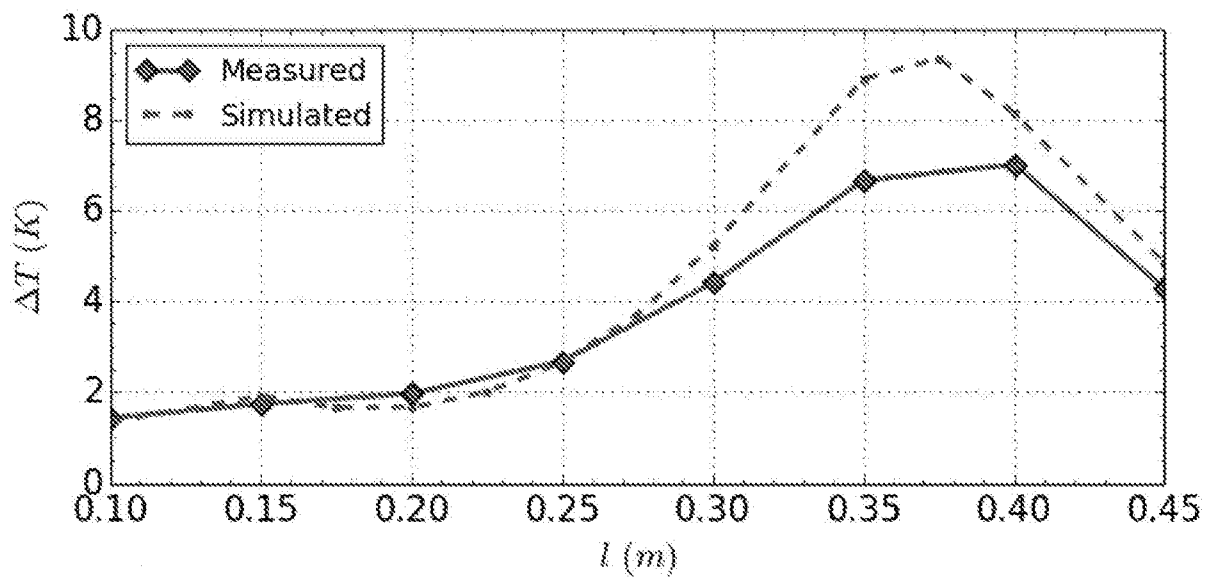
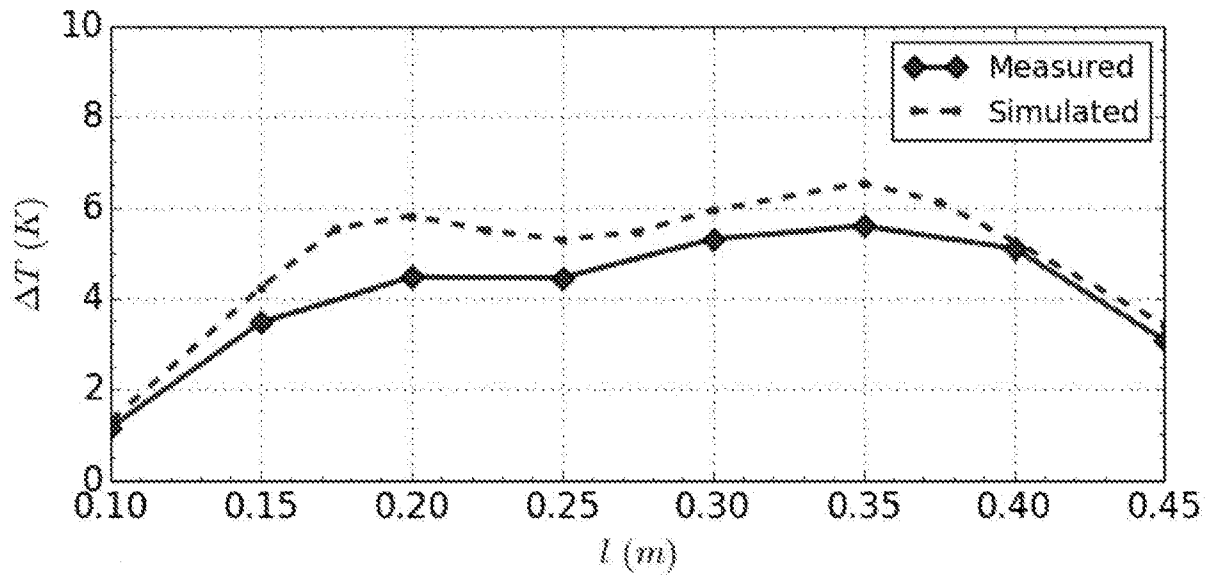

Figure 7b

Figure 8a

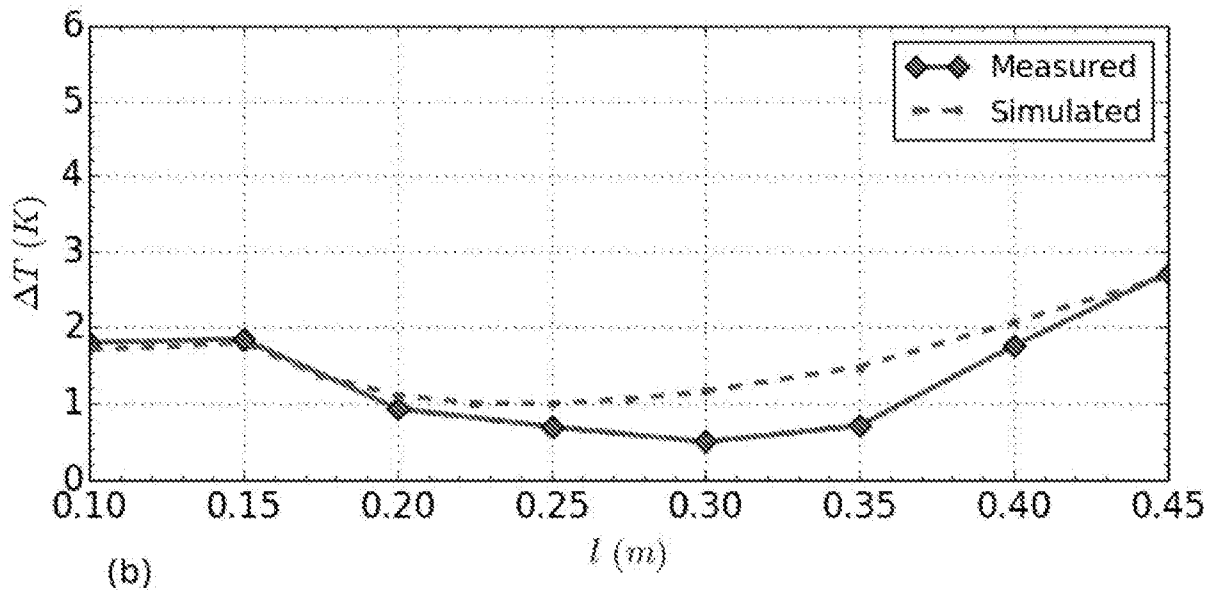
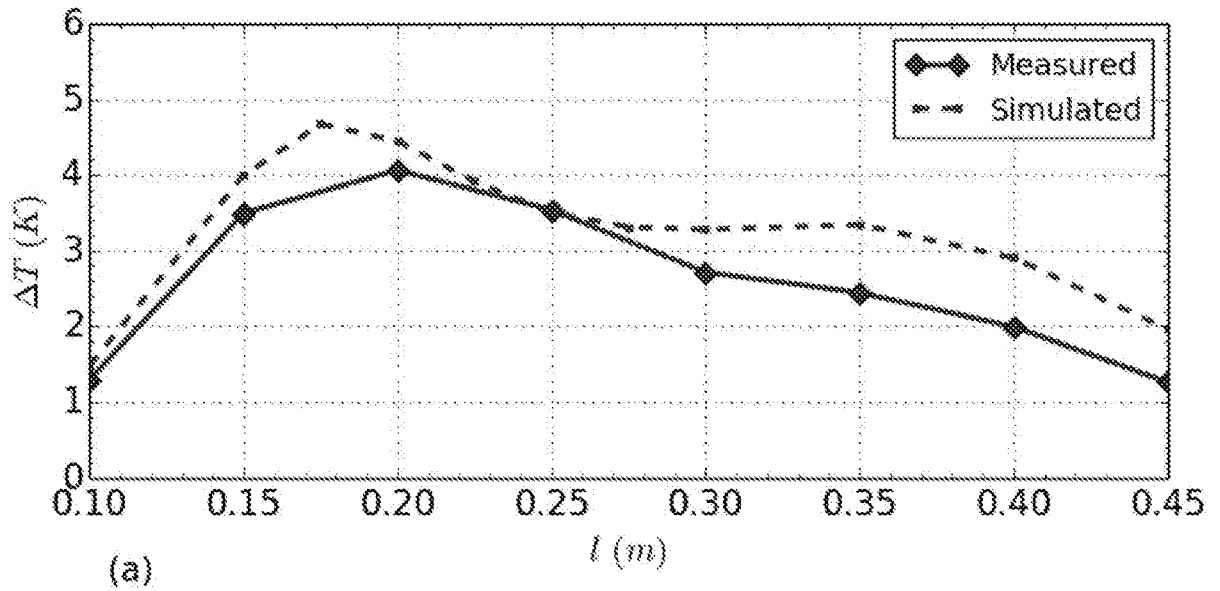
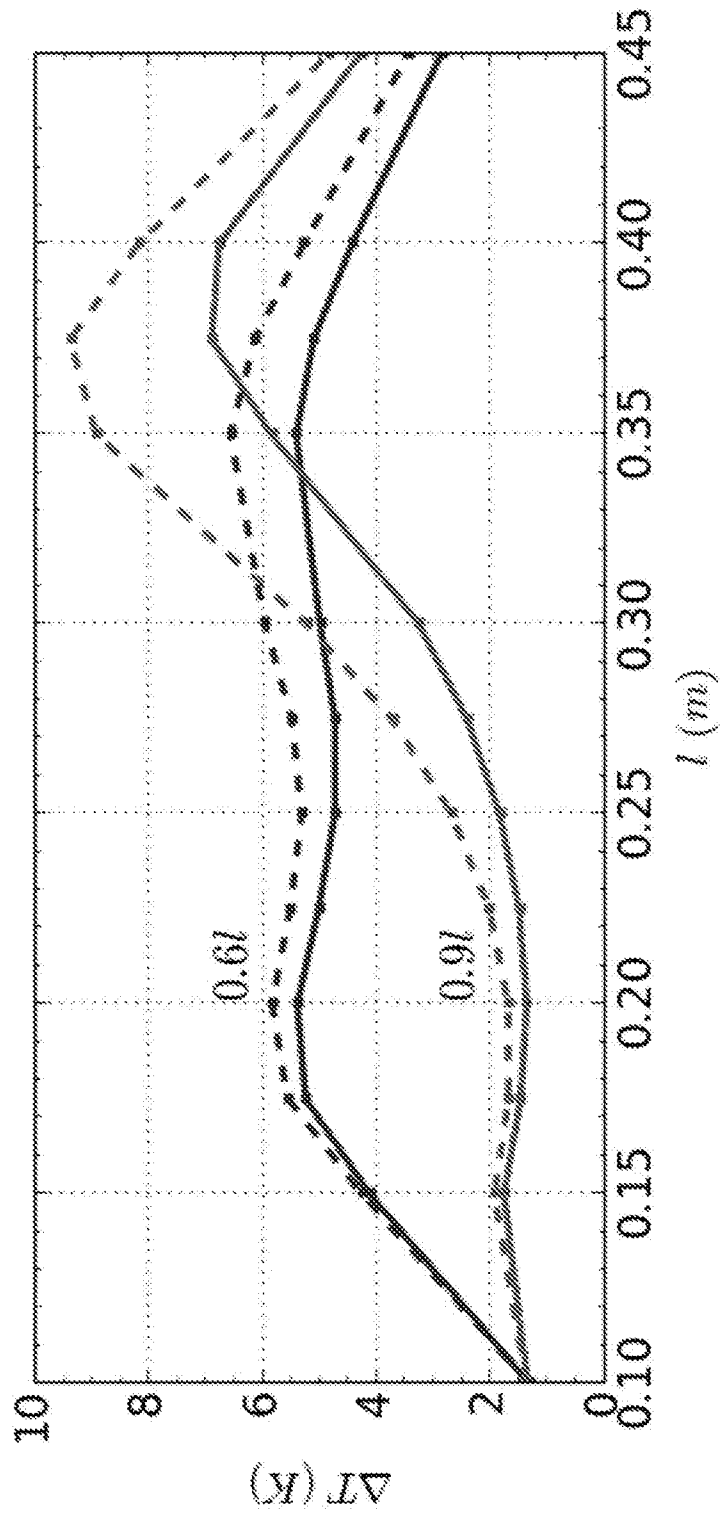

Figure 8b

Figure 9



## A. CLASSIFICATION OF SUBJECT MATTER

**A61N 1/08 (2006.01)**

According to International Patent Classification (IPC) or to both national classification and IPC

## B. FIELDS SEARCHED

Minimum documentation searched (classification system followed by classification symbols)

Documentation searched other than minimum documentation to the extent that such documents are included in the fields searched

Electronic data base consulted during the international search (name of data base and, where practicable, search terms used)

Database: EPODOC, WPIAP, TXTE, INSPEC; IPC/CPC Marks: A61N/LOW, A61N1, A61N1/08, A61N2001/086, A61N1/3718; and Keywords: Minimize, Shield, Decrease, Reflect, Divert, Direct, Lower, Deflect, Concentrate, Focus, Current, Heat, Electro, Magnet, RF, MRI, EMI, Eddy, Resonance, Interference, Filar, Lead Electrode and like words.

Applicant/Inventors searched in EPODOC using "Waikato" as Applicant; "McCabe S" or "Scott Jon" as Inventor and/or above IPC/CPC Marks.

Applicant/Inventors name searched in internal databases provided by IP Australia.

## C. DOCUMENTS CONSIDERED TO BE RELEVANT

Category*	Citation of document, with indication, where appropriate, of the relevant passages	Relevant to claim No.
	Documents are listed in the continuation of Box C	

 Further documents are listed in the continuation of Box C See patent family annex

* Special categories of cited documents:		
"A" document defining the general state of the art which is not considered to be of particular relevance	"T" later document published after the international filing date or priority date and not in conflict with the application but cited to understand the principle or theory underlying the invention	
"E" earlier application or patent but published on or after the international filing date	"X" document of particular relevance; the claimed invention cannot be considered novel or cannot be considered to involve an inventive step when the document is taken alone	
"L" document which may throw doubts on priority claim(s) or which is cited to establish the publication date of another citation or other special reason (as specified)	"Y" document of particular relevance; the claimed invention cannot be considered to involve an inventive step when the document is combined with one or more other such documents, such combination being obvious to a person skilled in the art	
"O" document referring to an oral disclosure, use, exhibition or other means	"&" document member of the same patent family	
"P" document published prior to the international filing date but later than the priority date claimed		

Date of the actual completion of the international search  
28 April 2017Date of mailing of the international search report  
28 April 2017

## Name and mailing address of the ISA/AU

AUSTRALIAN PATENT OFFICE  
PO BOX 200, WODEN ACT 2606, AUSTRALIA  
Email address: pct@ipaustalia.gov.au

## Authorised officer

Kiran Karve  
AUSTRALIAN PATENT OFFICE  
(ISO 9001 Quality Certified Service)  
Telephone No. 0262832824

INTERNATIONAL SEARCH REPORT		International application No.
C (Continuation).		<b>PCT/NZ2016/050182</b>
DOCUMENTS CONSIDERED TO BE RELEVANT		
Category*	Citation of document, with indication, where appropriate, of the relevant passages	Relevant to claim No.
X	US 2011/0230943 A1 (JOHNSON et al.) 22 September 2011 Figures 67 – 71; Paragraphs [0205], [0206], [0207]	1 - 22
A	US 8825179 B2 (CARDIAC PACEMAKERS, INC.) 02 September 2014 Whole Document.	1 - 22
A	US 2015/0057730 A1 (MEDTRONIC, INC.) 26 February 2015 Whole Document	1 - 22
A	US 2012/0109270 A1 (FOSTER) 03 May 2012 Whole Document	1 - 22
A	US 2008/0243218 A1 (BOTTOMLEY et al.) 02 October 2008 Entire Document.	1 - 22
A	McCabe, Steven Owen, and Jonathan B. Scott. "Cause and amelioration of MRI-induced heating through medical implant lead wires." In <i>21st Electronics New Zealand Conference (ENZCon)</i> . 2014. Entire Document.	1 - 22
L	McCabe, Steven, and Jonathan Scott. "A Novel Implant Electrode Design Safe in the RF Field of MRI Scanners." <i>IEEE Transactions on Microwave Theory and Techniques</i> (2017). Later document published after the international filing date or priority date and not in conflict with the application but cited to highlight Applicants disclosure of the claimed invention.	

**INTERNATIONAL SEARCH REPORT**

Information on patent family members

International application No.

**PCT/NZ2016/050182**

This Annex lists known patent family members relating to the patent documents cited in the above-mentioned international search report. The Australian Patent Office is in no way liable for these particulars which are merely given for the purpose of information.

<b>Patent Document/s Cited in Search Report</b>		<b>Patent Family Member/s</b>	
<b>Publication Number</b>	<b>Publication Date</b>	<b>Publication Number</b>	<b>Publication Date</b>
US 2011/0230943 A1	22 September 2011	US 2011230943 A1	22 Sep 2011
		US 8260435 B2	04 Sep 2012
		AU 1605100 A	22 May 2000
		AU 2003213646 A1	09 Sep 2003
		AU 2003225633 A1	09 Sep 2003
		CA 2349235 A1	11 May 2000
		CA 2420539 A1	28 Aug 2003
		CA 2446430 A1	04 Sep 2003
		CA 2446476 A1	04 Sep 2003
		CA 2482202 A1	24 Oct 2002
		CA 2485183 A1	23 Nov 2004
		CA 2507739 A1	10 Nov 2005
		CA 2516034 A1	02 Mar 2006
		CA 2536477 A1	21 Sep 2006
		CA 2601663 A1	13 Feb 2009
		CN 1762510 A	26 Apr 2006
		CN 1802185 A	12 Jul 2006
		CN 101321553 A	10 Dec 2008
		CN 101325985 A	17 Dec 2008
		CN 101325985 B	08 Jun 2011
		CN 101366665 A	18 Feb 2009
		CN 102019033 A	20 Apr 2011
		CN 102037528 A	27 Apr 2011
		EP 1126784 A1	29 Aug 2001
		EP 1126784 B1	16 Jan 2013
		EP 1479087 A1	24 Nov 2004
		EP 1479087 B1	28 Jul 2010
		EP 1488434 A1	22 Dec 2004
		EP 1488434 B1	12 Dec 2012
		EP 1626776 A2	22 Feb 2006
		EP 1632265 A1	08 Mar 2006
		EP 1704893 A1	27 Sep 2006
		EP 1707237 A2	04 Oct 2006
		EP 1743347 A1	17 Jan 2007
		EP 1743347 B1	26 Jun 2013
		EP 1754511 A2	21 Feb 2007

Due to data integration issues this family listing may not include 10 digit Australian applications filed since May 2001.

Form PCT/ISA/210 (Family Annex)(July 2009)

**INTERNATIONAL SEARCH REPORT**

Information on patent family members

International application No.

**PCT/NZ2016/050182**

This Annex lists known patent family members relating to the patent documents cited in the above-mentioned international search report. The Australian Patent Office is in no way liable for these particulars which are merely given for the purpose of information.

<b>Patent Document/s Cited in Search Report</b>		<b>Patent Family Member/s</b>	
<b>Publication Number</b>	<b>Publication Date</b>	<b>Publication Number</b>	<b>Publication Date</b>
		EP 1754511 B1	24 Feb 2010
		EP 1945297 A2	23 Jul 2008
		EP 1945297 B1	10 Aug 2016
		EP 2025361 A1	18 Feb 2009
		EP 2026870 A2	25 Feb 2009
		EP 2062525 A2	27 May 2009
		EP 2143466 A2	13 Jan 2010
		EP 2165734 A2	24 Mar 2010
		EP 2181502 A1	05 May 2010
		EP 2193823 A2	09 Jun 2010
		EP 2194548 A2	09 Jun 2010
		EP 2198913 A1	23 Jun 2010
		EP 2198914 A1	23 Jun 2010
		EP 2267894 A2	29 Dec 2010
		EP 2269200 A2	05 Jan 2011
		EP 2269200 B1	24 Sep 2014
		EP 2269688 A1	05 Jan 2011
		EP 2273675 A2	12 Jan 2011
		EP 2291219 A1	09 Mar 2011
		EP 2305344 A1	06 Apr 2011
		EP 2305344 B1	23 Jan 2013
		EP 2349453 A1	03 Aug 2011
		EP 2357017 A1	17 Aug 2011
		EP 2361425 A1	31 Aug 2011
		EP 2371281 A2	05 Oct 2011
		EP 2371281 B1	29 Apr 2015
		EP 2376183 A1	19 Oct 2011
		EP 2376184 A1	19 Oct 2011
		EP 2392382 A1	07 Dec 2011
		EP 2408520 A1	25 Jan 2012
		EP 2415499 A1	08 Feb 2012
		EP 2415499 B1	06 Apr 2016
		EP 2445433 A1	02 May 2012
		EP 2486952 A1	15 Aug 2012
		EP 2495014 A1	05 Sep 2012
		EP 2594314 A1	22 May 2013

Due to data integration issues this family listing may not include 10 digit Australian applications filed since May 2001.

**INTERNATIONAL SEARCH REPORT**

Information on patent family members

International application No.

**PCT/NZ2016/050182**

This Annex lists known patent family members relating to the patent documents cited in the above-mentioned international search report. The Australian Patent Office is in no way liable for these particulars which are merely given for the purpose of information.

<b>Patent Document/s Cited in Search Report</b>		<b>Patent Family Member/s</b>	
<b>Publication Number</b>	<b>Publication Date</b>	<b>Publication Number</b>	<b>Publication Date</b>
		EP 2617461 A1	24 Jul 2013
		EP 2628504 A1	21 Aug 2013
		EP 2630988 A1	28 Aug 2013
		EP 2630988 B1	19 Apr 2017
		EP 2636427 A1	11 Sep 2013
		EP 2835148 A1	11 Feb 2015
		EP 3081258 A1	19 Oct 2016
		EP 3103514 A1	14 Dec 2016
		JP 2006068541 A	16 Mar 2006
		JP 2006263468 A	05 Oct 2006
		JP 2007536760 A	13 Dec 2007
		JP 2009045425 A	05 Mar 2009
		JP 2009514617 A	09 Apr 2009
		JP 2009537276 A	29 Oct 2009
		JP 2011517970 A	23 Jun 2011
		JP 2012166029 A	06 Sep 2012
		US 6701176 B1	02 Mar 2004
		US 2003179536 A1	25 Sep 2003
		US 6765779 B2	20 Jul 2004
		US 2003213605 A1	20 Nov 2003
		US 6765780 B2	20 Jul 2004
		US 2003213604 A1	20 Nov 2003
		US 6888715 B2	03 May 2005
		US 2004201947 A1	14 Oct 2004
		US 6985347 B2	10 Jan 2006
		US 2005190527 A1	01 Sep 2005
		US 6987660 B2	17 Jan 2006
		US 2004257747 A1	23 Dec 2004
		US 6999818 B2	14 Feb 2006
		US 2005247475 A1	10 Nov 2005
		US 7012192 B2	14 Mar 2006
		US 7035076 B1	25 Apr 2006
		US 2006028784 A1	09 Feb 2006
		US 7035077 B2	25 Apr 2006
		US 2005007718 A1	13 Jan 2005
		US 7038900 B2	02 May 2006

Due to data integration issues this family listing may not include 10 digit Australian applications filed since May 2001.

Form PCT/ISA/210 (Family Annex)(July 2009)

**INTERNATIONAL SEARCH REPORT**

Information on patent family members

International application No.

**PCT/NZ2016/050182**

This Annex lists known patent family members relating to the patent documents cited in the above-mentioned international search report. The Australian Patent Office is in no way liable for these particulars which are merely given for the purpose of information.

<b>Patent Document/s Cited in Search Report</b>		<b>Patent Family Member/s</b>	
<b>Publication Number</b>	<b>Publication Date</b>	<b>Publication Number</b>	<b>Publication Date</b>
		US 2005219787 A1	06 Oct 2005
		US 7113387 B2	26 Sep 2006
		US 2006221543 A1	05 Oct 2006
		US 7136273 B2	14 Nov 2006
		US 2003199755 A1	23 Oct 2003
		US 7155271 B2	26 Dec 2006
		US 2007035910 A1	15 Feb 2007
		US 7199995 B2	03 Apr 2007
		US 2005248907 A1	10 Nov 2005
		US 7310216 B2	18 Dec 2007
		US 2007288058 A1	13 Dec 2007
		US 7363090 B2	22 Apr 2008
		US 2004167392 A1	26 Aug 2004
		US 7412276 B2	12 Aug 2008
		US 2006085043 A1	20 Apr 2006
		US 7489495 B2	10 Feb 2009
		US 2007019362 A1	25 Jan 2007
		US 7535693 B2	19 May 2009
		US 2006259093 A1	16 Nov 2006
		US 7623335 B2	24 Nov 2009
		US 2007279834 A1	06 Dec 2007
		US 7623336 B2	24 Nov 2009
		US 2010016936 A1	21 Jan 2010
		US 7689288 B2	30 Mar 2010
		US 2008161886 A1	03 Jul 2008
		US 7702387 B2	20 Apr 2010
		US 2010023000 A1	28 Jan 2010
		US 7751903 B2	06 Jul 2010
		US 2005197677 A1	08 Sep 2005
		US 7765005 B2	27 Jul 2010
		US 2008065181 A1	13 Mar 2008
		US 7787958 B2	31 Aug 2010
		US 2008058635 A1	06 Mar 2008
		US 7822460 B2	26 Oct 2010
		US 2003050557 A1	13 Mar 2003
		US 7844319 B2	30 Nov 2010

Due to data integration issues this family listing may not include 10 digit Australian applications filed since May 2001.

**INTERNATIONAL SEARCH REPORT**

Information on patent family members

International application No.

**PCT/NZ2016/050182**

This Annex lists known patent family members relating to the patent documents cited in the above-mentioned international search report. The Australian Patent Office is in no way liable for these particulars which are merely given for the purpose of information.

<b>Patent Document/s Cited in Search Report</b>		<b>Patent Family Member/s</b>	
<b>Publication Number</b>	<b>Publication Date</b>	<b>Publication Number</b>	<b>Publication Date</b>
		US 2008071313 A1	20 Mar 2008
		US 7853324 B2	14 Dec 2010
		US 2008116997 A1	22 May 2008
		US 7853325 B2	14 Dec 2010
		US 2008132987 A1	05 Jun 2008
		US 7899551 B2	01 Mar 2011
		US 2006212096 A1	21 Sep 2006
		US 7916013 B2	29 Mar 2011
		US 2009116167 A1	07 May 2009
		US 7917219 B2	29 Mar 2011
		US 2010231327 A1	16 Sep 2010
		US 7920916 B2	05 Apr 2011
		US 2007112398 A1	17 May 2007
		US 7945322 B2	17 May 2011
		US 2011004283 A1	06 Jan 2011
		US 7957806 B2	07 Jun 2011
		US 2011040343 A1	17 Feb 2011
		US 7966075 B2	21 Jun 2011
		US 2010331932 A1	30 Dec 2010
		US 7983763 B2	19 Jul 2011
		US 2010174349 A1	08 Jul 2010
		US 8000801 B2	16 Aug 2011
		US 2010241206 A1	23 Sep 2010
		US 8095224 B2	10 Jan 2012
		US 2006100506 A1	11 May 2006
		US 8099151 B2	17 Jan 2012
		US 8108042 B1	31 Jan 2012
		US 2012035698 A1	09 Feb 2012
		US 2010123547 A1	20 May 2010
		US 8115600 B2	14 Feb 2012
		US 2011213232 A1	01 Sep 2011
		US 8116862 B2	14 Feb 2012
		US 2012059445 A1	08 Mar 2012
		US 8145324 B1	27 Mar 2012
		US 2011144734 A1	16 Jun 2011
		US 8155760 B2	10 Apr 2012

Due to data integration issues this family listing may not include 10 digit Australian applications filed since May 2001.

Form PCT/ISA/210 (Family Annex)(July 2009)

**INTERNATIONAL SEARCH REPORT**

Information on patent family members

International application No.

**PCT/NZ2016/050182**

This Annex lists known patent family members relating to the patent documents cited in the above-mentioned international search report. The Australian Patent Office is in no way liable for these particulars which are merely given for the purpose of information.

<b>Patent Document/s Cited in Search Report</b>		<b>Patent Family Member/s</b>	
<b>Publication Number</b>	<b>Publication Date</b>	<b>Publication Number</b>	<b>Publication Date</b>
		US 2010100164 A1	22 Apr 2010
		US 8175700 B2	08 May 2012
		US 2010134951 A1	03 Jun 2010
		US 8179658 B2	15 May 2012
		US 2011208030 A1	25 Aug 2011
		US 8180448 B2	15 May 2012
		US 2009243756 A1	01 Oct 2009
		US 8195295 B2	05 Jun 2012
		US 2011201912 A1	18 Aug 2011
		US 8200328 B2	12 Jun 2012
		US 2010324639 A1	23 Dec 2010
		US 8200342 B2	12 Jun 2012
		US 2010217262 A1	26 Aug 2010
		US 8219208 B2	10 Jul 2012
		US 2010324640 A1	23 Dec 2010
		US 8224440 B2	17 Jul 2012
		US 2012078333 A1	29 Mar 2012
		US 8224462 B2	17 Jul 2012
		US 2012029342 A1	02 Feb 2012
		US 8239041 B2	07 Aug 2012
		US 2006247684 A1	02 Nov 2006
		US 8244370 B2	14 Aug 2012
		US 8244373 B1	14 Aug 2012
		US 2010194541 A1	05 Aug 2010
		US 8248232 B2	21 Aug 2012
		US 2010060431 A1	11 Mar 2010
		US 8253555 B2	28 Aug 2012
		US 2010222856 A1	02 Sep 2010
		US 8275466 B2	25 Sep 2012
		US 2010328049 A1	30 Dec 2010
		US 8299899 B2	30 Oct 2012
		US 2012161901 A1	28 Jun 2012
		US 8301243 B2	30 Oct 2012
		US 2011245644 A1	06 Oct 2011
		US 8311628 B2	13 Nov 2012
		US 2011029043 A1	03 Feb 2011

Due to data integration issues this family listing may not include 10 digit Australian applications filed since May 2001.

**INTERNATIONAL SEARCH REPORT**

Information on patent family members

International application No.

**PCT/NZ2016/050182**

This Annex lists known patent family members relating to the patent documents cited in the above-mentioned international search report. The Australian Patent Office is in no way liable for these particulars which are merely given for the purpose of information.

<b>Patent Document/s Cited in Search Report</b>		<b>Patent Family Member/s</b>	
<b>Publication Number</b>	<b>Publication Date</b>	<b>Publication Number</b>	<b>Publication Date</b>
		US 8321032 B2	27 Nov 2012
		US 2010321163 A1	23 Dec 2010
		US 8326435 B2	04 Dec 2012
		US 2012188027 A1	26 Jul 2012
		US 8364283 B2	29 Jan 2013
		US 2012139702 A1	07 Jun 2012
		US 8410899 B2	02 Apr 2013
		US 2011147062 A1	23 Jun 2011
		US 8422195 B2	16 Apr 2013
		US 2012262250 A1	18 Oct 2012
		US 8433410 B2	30 Apr 2013
		US 2011054582 A1	03 Mar 2011
		US 8437865 B2	07 May 2013
		US 2010208397 A1	19 Aug 2010
		US 8447414 B2	21 May 2013
		US 2010191236 A1	29 Jul 2010
		US 8457760 B2	04 Jun 2013
		US 2011066212 A1	17 Mar 2011
		US 8463375 B2	11 Jun 2013
		US 2009288280 A1	26 Nov 2009
		US 8468664 B2	25 Jun 2013
		US 2011043297 A1	24 Feb 2011
		US 8483840 B2	09 Jul 2013
		US 2010168821 A1	01 Jul 2010
		US 8509913 B2	13 Aug 2013
		US 8577453 B1	05 Nov 2013
		US 2013317584 A1	28 Nov 2013
		US 2013201005 A1	08 Aug 2013
		US 8581694 B2	12 Nov 2013
		US 2010023095 A1	28 Jan 2010
		US 8600519 B2	03 Dec 2013
		US 2011213233 A1	01 Sep 2011
		US 8649857 B2	11 Feb 2014
		US 2013184797 A1	18 Jul 2013
		US 8653384 B2	18 Feb 2014
		US 2009259265 A1	15 Oct 2009

Due to data integration issues this family listing may not include 10 digit Australian applications filed since May 2001.

Form PCT/ISA/210 (Family Annex)(July 2009)

**INTERNATIONAL SEARCH REPORT**

Information on patent family members

International application No.

**PCT/NZ2016/050182**

This Annex lists known patent family members relating to the patent documents cited in the above-mentioned international search report. The Australian Patent Office is in no way liable for these particulars which are merely given for the purpose of information.

<b>Patent Document/s Cited in Search Report</b>		<b>Patent Family Member/s</b>	
<b>Publication Number</b>	<b>Publication Date</b>	<b>Publication Number</b>	<b>Publication Date</b>
		US 8660645 B2	25 Feb 2014
		US 2013226273 A1	29 Aug 2013
		US 8670841 B2	11 Mar 2014
		US 2013245413 A1	19 Sep 2013
		US 8712544 B2	29 Apr 2014
		US 2013253297 A1	26 Sep 2013
		US 8751013 B2	10 Jun 2014
		US 2010185263 A1	22 Jul 2010
		US 8761895 B2	24 Jun 2014
		US 2010318160 A1	16 Dec 2010
		US 8788057 B2	22 Jul 2014
		US 2011001610 A1	06 Jan 2011
		US 8810405 B2	19 Aug 2014
		US 2010280584 A1	04 Nov 2010
		US 8849403 B2	30 Sep 2014
		US 8855768 B1	07 Oct 2014
		US 2014288619 A1	25 Sep 2014
		US 8855785 B1	07 Oct 2014
		US 2013235550 A1	12 Sep 2013
		US 8868189 B2	21 Oct 2014
		US 2012265045 A1	18 Oct 2012
		US 8882763 B2	11 Nov 2014
		US 2008269591 A1	30 Oct 2008
		US 8897887 B2	25 Nov 2014
		US 2012071956 A1	22 Mar 2012
		US 8903505 B2	02 Dec 2014
		US 2014172059 A1	19 Jun 2014
		US 8918189 B2	23 Dec 2014
		US 2013184796 A1	18 Jul 2013
		US 8938309 B2	20 Jan 2015
		US 2010198312 A1	05 Aug 2010
		US 8977355 B2	10 Mar 2015
		US 2010160997 A1	24 Jun 2010
		US 8989870 B2	24 Mar 2015
		US 2012253340 A1	04 Oct 2012
		US 8996126 B2	31 Mar 2015

Due to data integration issues this family listing may not include 10 digit Australian applications filed since May 2001.

Form PCT/ISA/210 (Family Annex)(July 2009)

**INTERNATIONAL SEARCH REPORT**

Information on patent family members

International application No.

**PCT/NZ2016/050182**

This Annex lists known patent family members relating to the patent documents cited in the above-mentioned international search report. The Australian Patent Office is in no way liable for these particulars which are merely given for the purpose of information.

<b>Patent Document/s Cited in Search Report</b>		<b>Patent Family Member/s</b>	
<b>Publication Number</b>	<b>Publication Date</b>	<b>Publication Number</b>	<b>Publication Date</b>
		US 2014330357 A1	06 Nov 2014
		US 9002471 B2	07 Apr 2015
		US 2014240060 A1	28 Aug 2014
		US 9008799 B2	14 Apr 2015
		US 2014168850 A1	19 Jun 2014
		US 9014808 B2	21 Apr 2015
		US 2014296952 A1	02 Oct 2014
		US 9031670 B2	12 May 2015
		US 2013289666 A1	31 Oct 2013
		US 9037258 B2	19 May 2015
		US 2008195180 A1	14 Aug 2008
		US 9042999 B2	26 May 2015
		US 2008049376 A1	28 Feb 2008
		US 9061139 B2	23 Jun 2015
		US 2013286537 A1	31 Oct 2013
		US 9064640 B2	23 Jun 2015
		US 9071221 B1	30 Jun 2015
		US 2015207484 A1	23 Jul 2015
		US 2014194964 A1	10 Jul 2014
		US 9108066 B2	18 Aug 2015
		US 2012277841 A1	01 Nov 2012
		US 9119968 B2	01 Sep 2015
		US 2014036409 A1	06 Feb 2014
		US 9233253 B2	12 Jan 2016
		US 2015031975 A1	29 Jan 2015
		US 9242090 B2	26 Jan 2016
		US 2014074211 A1	13 Mar 2014
		US 9248283 B2	02 Feb 2016
		US 2013070387 A1	21 Mar 2013
		US 9251960 B2	02 Feb 2016
		US 2012296190 A1	22 Nov 2012
		US 9254377 B2	09 Feb 2016
		US 2013073021 A1	21 Mar 2013
		US 9295828 B2	29 Mar 2016
		US 2012101364 A1	26 Apr 2012
		US 9301705 B2	05 Apr 2016

Due to data integration issues this family listing may not include 10 digit Australian applications filed since May 2001.

Form PCT/ISA/210 (Family Annex)(July 2009)

**INTERNATIONAL SEARCH REPORT**

Information on patent family members

International application No.

**PCT/NZ2016/050182**

This Annex lists known patent family members relating to the patent documents cited in the above-mentioned international search report. The Australian Patent Office is in no way liable for these particulars which are merely given for the purpose of information.

<b>Patent Document/s Cited in Search Report</b>		<b>Patent Family Member/s</b>	
<b>Publication Number</b>	<b>Publication Date</b>	<b>Publication Number</b>	<b>Publication Date</b>
		US 2016008595 A1	14 Jan 2016
		US 9352150 B2	31 May 2016
		US 2015343224 A1	03 Dec 2015
		US 9427596 B2	30 Aug 2016
		US 2016151635 A1	02 Jun 2016
		US 9463329 B2	11 Oct 2016
		US 2013338747 A1	19 Dec 2013
		US 9468750 B2	18 Oct 2016
		US 2014161973 A1	12 Jun 2014
		US 9492659 B2	15 Nov 2016
		US 2015134039 A1	14 May 2015
		US 9511220 B2	06 Dec 2016
		US 2005201039 A1	15 Sep 2005
		US 2007083244 A1	12 Apr 2007
		US 2007088416 A1	19 Apr 2007
		US 2007123949 A1	31 May 2007
		US 2008119919 A1	22 May 2008
		US 2009163980 A1	25 Jun 2009
		US 2009163981 A1	25 Jun 2009
		US 2010191306 A1	29 Jul 2010
		US 2010222857 A1	02 Sep 2010
		US 2011022140 A1	27 Jan 2011
		US 2011057037 A1	10 Mar 2011
		US 2011288403 A1	24 Nov 2011
		US 2011306860 A1	15 Dec 2011
		US 2012046723 A1	23 Feb 2012
		US 2012053667 A1	01 Mar 2012
		US 2012083864 A1	05 Apr 2012
		US 2012256704 A1	11 Oct 2012
		US 2014168917 A1	19 Jun 2014
		US 2014330355 A1	06 Nov 2014
		US 2015066124 A1	05 Mar 2015
		US 2015116053 A1	30 Apr 2015
		US 2015217111 A1	06 Aug 2015
		US 2015314131 A1	05 Nov 2015
		US 2016263373 A1	15 Sep 2016

Due to data integration issues this family listing may not include 10 digit Australian applications filed since May 2001.

Form PCT/ISA/210 (Family Annex)(July 2009)

**INTERNATIONAL SEARCH REPORT**

Information on patent family members

International application No.

**PCT/NZ2016/050182**

This Annex lists known patent family members relating to the patent documents cited in the above-mentioned international search report. The Australian Patent Office is in no way liable for these particulars which are merely given for the purpose of information.

<b>Patent Document/s Cited in Search Report</b>		<b>Patent Family Member/s</b>	
<b>Publication Number</b>	<b>Publication Date</b>	<b>Publication Number</b>	<b>Publication Date</b>
		US 2016263384 A1	15 Sep 2016
		US 2016367821 A1	22 Dec 2016
		US 2017080239 A1	23 Mar 2017
		US 2017087354 A1	30 Mar 2017
		US 2017087355 A1	30 Mar 2017
		US 2017087356 A1	30 Mar 2017
		WO 0025672 A1	11 May 2000
		WO 02083016 A1	24 Oct 2002
		WO 03073449 A1	04 Sep 2003
		WO 03073450 A1	04 Sep 2003
		WO 2004105572 A2	09 Dec 2004
		WO 2005114685 A1	01 Dec 2005
		WO 2007102893 A2	13 Sep 2007
		WO 2007117302 A2	18 Oct 2007
		WO 2007145671 A2	21 Dec 2007
		WO 2009029408 A1	05 Mar 2009
		WO 2009117599 A2	24 Sep 2009
		WO 2010008833 A1	21 Jan 2010
		WO 2010051265 A1	06 May 2010
		WO 2010059376 A1	27 May 2010
		WO 2010081155 A1	15 Jul 2010
		WO 2010081167 A1	15 Jul 2010
		WO 2010107608 A1	23 Sep 2010
		WO 2010107926 A1	23 Sep 2010
		WO 2010151366 A1	29 Dec 2010
		WO 2011002533 A1	06 Jan 2011
		WO 2011037648 A1	31 Mar 2011
		WO 2011087532 A1	21 Jul 2011

Due to data integration issues this family listing may not include 10 digit Australian applications filed since May 2001.

Form PCT/ISA/210 (Family Annex)(July 2009)

## INTERNATIONAL SEARCH REPORT

Information on patent family members

International application No.

PCT/NZ2016/050182

This Annex lists known patent family members relating to the patent documents cited in the above-mentioned international search report. The Australian Patent Office is in no way liable for these particulars which are merely given for the purpose of information.

Patent Document/s Cited in Search Report		Patent Family Member/s	
Publication Number	Publication Date	Publication Number	Publication Date
US 8825179 B2	02 September 2014	US 2013282093 A1	24 Oct 2013
		US 8825179 B2	02 Sep 2014
		AU 2013249088 A1	21 Aug 2014
		AU 2013249088 B2	03 Dec 2015
		EP 2838605 A2	25 Feb 2015
		JP 2015508701 A	23 Mar 2015
		JP 5905611 B2	20 Apr 2016
		WO 2013159031 A2	24 Oct 2013
US 2015/0057730 A1	26 February 2015	US 2015057730 A1	26 Feb 2015
		US 9149633 B2	06 Oct 2015
		EP 2667929 A2	04 Dec 2013
		US 2014052227 A1	20 Feb 2014
		US 8880188 B2	04 Nov 2014
		WO 2012103419 A2	02 Aug 2012
US 2012/0109270 A1	03 May 2012	US 2012109270 A1	03 May 2012
		US 8688236 B2	01 Apr 2014
		EP 2282807 A1	16 Feb 2011
		EP 2282807 B1	23 Apr 2014
		JP 2011518608 A	30 Jun 2011
		JP 5399475 B2	29 Jan 2014
		US 2009281608 A1	12 Nov 2009
		US 8103360 B2	24 Jan 2012
US 2008/0243218 A1	02 October 2008	US 2008243218 A1	02 Oct 2008
		US 9492651 B2	15 Nov 2016
		AU 2008227102 A1	25 Sep 2008
		AU 2008227102 B2	16 May 2013
		AU 2008229465 A1	25 Sep 2008
		AU 2008229465 B2	22 Aug 2013
		CA 2679498 A1	25 Sep 2008
		CA 2681367 A1	25 Sep 2008
		EP 2131918 A1	16 Dec 2009
		EP 2131918 B1	23 Apr 2014
		EP 2134413 A2	23 Dec 2009

Due to data integration issues this family listing may not include 10 digit Australian applications filed since May 2001.

Form PCT/ISA/210 (Family Annex)(July 2009)

**INTERNATIONAL SEARCH REPORT**

Information on patent family members

International application No.

**PCT/NZ2016/050182**

This Annex lists known patent family members relating to the patent documents cited in the above-mentioned international search report. The Australian Patent Office is in no way liable for these particulars which are merely given for the purpose of information.

<b>Patent Document/s Cited in Search Report</b>		<b>Patent Family Member/s</b>	
<b>Publication Number</b>	<b>Publication Date</b>	<b>Publication Number</b>	<b>Publication Date</b>
		EP 2134413 B1	21 Sep 2016
		EP 2705874 A1	12 Mar 2014
		EP 2705874 B1	28 Sep 2016
		EP 2705875 A1	12 Mar 2014
		EP 2705875 B1	23 Nov 2016
		JP 2010522020 A	01 Jul 2010
		JP 5568315 B2	06 Aug 2014
		JP 2010522021 A	01 Jul 2010
		JP 5568316 B2	06 Aug 2014
		KR 20100015703 A	12 Feb 2010
		KR 101413677 B1	01 Jul 2014
		KR 20100015702 A	12 Feb 2010
		KR 101413679 B1	01 Jul 2014
		US 2008262584 A1	23 Oct 2008
		US 9248270 B2	02 Feb 2016
		US 2016220812 A1	04 Aug 2016
		WO 2008115383 A2	25 Sep 2008
		WO 2008115426 A1	25 Sep 2008

**End of Annex**

Due to data integration issues this family listing may not include 10 digit Australian applications filed since May 2001.

Form PCT/ISA/210 (Family Annex)(July 2009)