



THE UNIVERSITY OF  
**WAIKATO**  
*Te Whare Wānanga o Waikato*

Research Commons

<http://waikato.researchgateway.ac.nz/>

## Research Commons at the University of Waikato

### Copyright Statement:

The digital copy of this thesis is protected by the Copyright Act 1994 (New Zealand).

The thesis may be consulted by you, provided you comply with the provisions of the Act and the following conditions of use:

- Any use you make of these documents or images must be for research or private study purposes only, and you may not make them available to any other person.
- Authors control the copyright of their thesis. You will recognise the author's right to be identified as the author of the thesis, and due acknowledgement will be made to the author where appropriate.
- You will obtain the author's permission before publishing any material from the thesis.

**BIOLOGY OF COMMON BULLY (*GOBIOMORPHUS COTIDIANUS*)  
POPULATIONS IN THE TARAWERA AND RANGITAIKI RIVERS:  
REPRODUCTIVE ISOLATION BY INLAND DISTANCE OR EFFLUENT  
DISCHARGES?**

A thesis  
submitted in partial fulfilment  
of  
the requirements for the Degree  
of  
Master of Science in Biological Sciences  
at  
The University of Waikato  
by

**Natalie Anne Bleackley**



## Abstract

Previous research identified distinct genetic, life-history and reproductive differences between populations of common bully (*Gobiomorphus cotidianus*) upstream and downstream of a pulp and paper mill outfall on the Tarawera River in the Bay of Plenty, New Zealand. This thesis sought to investigate the distribution of amphidromous and non-amphidromous common bully in the Tarawera River by examining fish collected from upstream (37 km inland) and downstream (20 km inland) locations and comparing them to fish from similar inland locations (40 km and 17 km inland, respectively) in the nearby Rangitaiki River. Otolith microchemistry revealed life-history differences between upstream and downstream populations and stable isotope analysis ensured long-term site residency. Amphidromy dominated in the downstream river populations, while the disappearance of diadromous fish generally occurred with inland distance. A mixture of diadromous and non-diadromous fish were found in the upstream Rangitaiki, while a complete absence of diadromous recruits was found in the upstream Tarawera River. A reduction in oculoscapular canal structures also coincided with loss of diadromy in fish from both rivers. Temporal reproductive divergence was investigated through track annual trends in gonadosomatic index.

The Tarawera River receives significant inputs from numerous industrial, municipal and natural sources, most notably from two pulp and paper mills. In the absence physical barriers in the Tarawera, it has been hypothesised that the lack of diadromous recruits in the upstream Tarawera River may be related to aquatic discharges in the downstream river. A behavioural study was performed to examine the hypothesis that pulp and paper mill effluent may be acting as a chemical barrier to fish migration within the river. A dual-choice chamber was employed to examine the responses of common bully exposed to a range of effluent concentrations (100, 50, 25, 12.5, 0% v/v). Fish exhibited significant avoidance responses when exposed to 100 and 50% effluent concentration, while no avoidance was observed at effluent concentrations below 50%. This study demonstrated that common bully show a strong preference for river water when simultaneously exposed to effluent, albeit at environmentally unrealistic concentrations (i.e. >15%), implicating potential for this effluent to act as a chemical barrier in the Tarawera River.

Following the establishment of reproductive timing of common bully in the Tarawera River, a wild fish health assessment was undertaken to investigate the effects of long-term effluent exposure in situ. Adult common bully were sampled downstream of the mill influence and compared to an appropriate reference population from the downstream Rangitaiki River. Male and female fish from the Tarawera River demonstrated 6- to 9-fold greater ethoxyresorufin-*O*-deethylase (EROD) activity compared to reference fish, indicating exposure to organic contaminants in this river. Tarawera females showed some minor variation in hematological variables including decreased mean cell volume (MCV), mean cell haemoglobin (MCH) and increased total white blood cell count (WBCC) suggestive of an immune response. Slightly greater ovarian follicular steroid production in Tarawera fish potentially indicates some form of endocrine alteration. However, this response may also be related to differences in reproductive synchrony and gonadal development between the two fish populations.

## **Acknowledgements**

I cannot thank enough my two supervisors Mike Landman and Nick Ling. Their enthusiasm for the project, and their valuable contribution throughout the whole of my project was unsurpassed. A large proportion of this research involved fishing. Fishing, fishing, and more fishing! Mike, Nick, and Jeroen, thanks for the endless hours of help in the field, rain or shine, day and night. Jeroen, thanks for waking me up every morning of fishing with a V, for providing constant entertainment in the field, and for going for a 'dip' in the Tarawera River to just to get my trap back, now that's dedication! A special thanks must go to Sean Taylor, for although he seems to take on the work of ten men, he still managed to contribute greatly to the laboratory component of my research. Your unsurpassed analytical skills are no doubt a blessing and a curse. Thanks also to Marie, Sheree, and Garrick, for lending a hand in the field when needed, and to Pixie for all her helpful errands. My gratitude goes to Steve Cameron, Matt Prentice, and Ray Tana, for showing me the ropes of the LA-ICPMS for otolith microchemistry, and to Brendan Hicks for his insights regarding the ecology section of my thesis. Mike van den Heuvel, whom was the first to introduce me to the 'bullies' and taught me my fishing skills many years ago, also provided helpful comments regarding the impact section of this work from his side of the world. Louis Tremblay and the team at Landcare (Christchurch) were great in providing fast turnaround of my EROD samples. My appreciation also extends to include Paul Scholes (EBOP) for obtaining the seawater samples, and to Nick Eynon-Richards of Carter Holt Harvey Tasman and Rob Donald of Norske Skog Tasman for their information regarding the mill processes and treatment systems. In addition, a mention must go out to the farmers along the Tarawera River, particularly Colin and Peter, for being so great and allowing me through their properties throughout the year to reach my fishing sites. An apology to my friends for neglecting them for so long, John especially. Financial support for this project was provided by Scion Research, the Tertiary Education Commission (Enterprise Scholarship), the Foundation for Research Science and Technology and Environment Bay of Plenty.

Lastly, and most importantly, my warmest and heartfelt 'thank you' to the people I love the most. Mum, dad, nana, Mims and Cath you have always been there for me, and I cannot put in words how much you all mean to me. Kai, I couldn't have done this without your constant love and support. Thanks for staying up late with me, and for putting a smile on my face even at the most stressful times.

As a final note, in case I've missed anyone out, I assure you it was not on purpose, I am severely sleep deprived and writing this literally in my final few hours, a bottle of wine your way if I've done so.

## Table of Contents

Abstract .....	ii
Acknowledgements .....	iv
Table of Contents .....	vi
List of Tables .....	ix
List of Figures .....	xi
List of Plates.....	xiii
Chapter One .....	14
General Introduction .....	14
1.1 General Introduction .....	15
1.2 Anthropogenic impacts in large rivers .....	15
1.3 Pulp and paper mill impacts .....	16
1.4 Migratory strategies in fishes .....	17
1.5 The New Zealand freshwater Gobiidae.....	19
1.5.1 Sentinel species for pollution monitoring .....	20
1.6 Study Site .....	21
1.6.1 The Tarawera and Rangitaiki Rivers .....	22
1.6.2 Pulp and Paper Mill Descriptions .....	26
1.7 An overview of recent biota monitoring .....	27
1.7.1 Tarawera River fisheries monitoring .....	27
1.7.2 Pulp and paper effluent environmental effects assessments .....	28
1.7.3 Monitoring wild common bully populations in the Tarawera River....	31
1.8 Research aims .....	32
Chapter Two.....	33
Ecology of common bully in the Tarawera and Rangitaiki Rivers.....	33
2.1 Introduction .....	34
2.2 Materials and Methods .....	38
2.2.1 Sampling sites and fish capture.....	38
2.2.2 Sampling protocol .....	39
2.2.3 Tissue stable isotope analysis.....	39
2.2.4 Otolith microchemistry .....	39
2.2.5 Identification of canal morphotypes.....	42
2.2.6 Vertebral counts .....	44

2.2.7 Statistical analysis and calculations .....	44
2.3 Results .....	44
2.3.1 Seasonal patterns in reproductive development and energy allocation	44
2.3.2 Stable isotopes.....	48
2.3.3 Vertebrae numbers .....	49
2.3.4 Head canal morphotypes .....	49
2.3.5 Elemental water analysis and otolith microchemistry .....	52
2.4 Discussion .....	55
Chapter Three.....	62
Avoidance response of common bully exposed to pulp and paper effluent .....	62
3.2 Introduction .....	63
3.2 Materials and methods .....	64
3.2.1 Animals .....	64
3.2.2 Water and effluent chemistry .....	65
3.2.3 Preference experimentation.....	67
3.2.3.1 Experimental apparatus.....	67
3.2.3.2 Experimental protocol.....	67
3.2.4 Statistics .....	68
3.2.5 Ethics Statement.....	69
3.3 Results .....	69
3.3.1 Water and effluent chemistry .....	69
3.3.2 Preference experiment.....	69
3.4 Discussion .....	73
Chapter Four .....	76
Pulp and paper mill effluent impact assessment .....	76
4.1 Introduction.....	77
4.2 Materials and methods .....	80
4.2.1 Study site and fish capture .....	80
4.2.2 Sampling protocol .....	80
4.2.3 Haematology .....	81
4.2.3.1 Haemoglobin.....	81
4.2.3.2 Haematocrit.....	82
4.2.3.3 Flow cytometric analysis of whole blood .....	82
4.2.3.4 Leukocyte Differential counts.....	83

4.2.5 Ovarian carotenoid analysis .....	83
4.2.6 In vitro ovarian steroid production.....	84
4.2.7 Sex steroid analysis .....	84
4.2.8 Ethoxyresorufin-O-deethylase (EROD) activity.....	85
4.2.9 Water and sediment chemistry .....	85
4.2.10 Statistics .....	86
4.3. Results .....	87
4.3.1 Physiological indices.....	87
4.3.1 Hematology .....	88
4.3.6 Ethoxyresorufin-O-deethylase (EROD) activity.....	90
4.3.4 Ovarian steroid production.....	90
4.3.3 Ovarian carotenoid analysis .....	91
4.3.7 Water and sediment chemistry .....	93
4.3 Discussion .....	95
Chapter Five .....	100
General Conclusions .....	100
References .....	104

## List of Tables

Table 2.1. Descriptive analyses of otolith and vertebral counts for each sample site. UT = upstream Tarawera, DT = downstream Tarawera, UR = upstream Rangitaiki, DR = downstream Rangitaiki. NO = number of samples included in otolith analyses, %ND = proportion of non-diadromous fish, %D = proportion of diadromous fish, NV = number of samples included in vertebral analyses, %29 = number of fish with 29 vertebrae, %28 = number of fish with 28 vertebrae.....	50
Table 2.2. Meristic analyses of oculoscapular lateral line canals. Type 1, 2, 3 and 4 = proportion of respective morphotype in sample site. UT = Upstream Tarawera, DT = Downstream Tarawera, UR = Upstream Rangitaiki, DR = Downstream Rangitaiki. N = number of individual fish per sample site included in morphological analyses.....	50
Table 2.3. Mean ( $\pm$ SEM) seasonal water elemental chemistry results for river sites (UT = upstream Tarawera, DT = downstream Tarawera, UR = upstream Rangitaiki, DR = downstream Rangitaiki) and coastal seawater samples. Salt water detection limits are high due to sample dilution required for ICPMS analysis. All units are in $\mu\text{g/L}$ . n.d = below detection limit.....	53
Table 3.1. Comparison of the physicochemical characteristics, including pH and conductivity ( $\mu\text{S/cm}$ ), of the control water (mean, ( $\pm$ St.Dev, n)) and TMP/BKME effluent treatments.....	70
Table 3.2. Organic extractive concentrations ( $\mu\text{g/L}$ ) in Tarawera River water and in undiluted whole Tasman Mill effluent.....	72
Table 4.1. Mean ( $\pm$ SEM, n) of size and somatic indices in male and female common bully. Asterisks indicate significant difference ( $p < 0.05$ ) in ANOVA between sample sites.....	87
Table 4.2. Mean ( $\pm$ SEM, n) blood parameters for male and female common bully. Asterisks indicate significant difference ( $p < 0.05$ ) in ANOVA between site parameters.....	89
Table 4.3. Organic extractives for river water samples collected from the downstream Tarawera and Rangitaiki Rivers sampling sites. Concentrations ( $\mu\text{g/L}$ .) are presented for each major compound class analysed.....	94

Table 4.4. Organic extractives for sediment samples from the Tarawera and Rangitaiki River sampling sites. Also included was an upstream reference for each river system. Concentrations ( $\mu\text{g/g}$  dry sediment) are presented for each major compound class analysed..... 94

## List of Figures

Figure 1.1. Common bully ( <i>G. cotidianus</i> ) distribution throughout New Zealand recorded by the New Zealand Freshwater Fish Database (NZFFD), NIWA ( <a href="http://www.niwa.cri.nz/services/free/nzffd">http://www.niwa.cri.nz/services/free/nzffd</a> ). .....	20
Figure 1.2. Map of site locations in the Tarawera and Rangitaiki Rivers, Bay of Plenty, New Zealand. Latitude and longitude for sample locations are as follows; Upstream Tarawera (UT = 38°06' 12.2" S, 176° 42' 14.1" E; Downstream Tarawera (DT = 38° 01' 22.5" S, 176° 44' 18.5" E); Upstream Rangitaiki (UR = 38° 06' 47.9" S, 176° 48' 46.3" E), and Downstream Rangitaiki (DR = 38° 00' 11.2" S, 176° 49' 06.0" E). .....	22
Figure 1.3. Summary of fish exposure assessments based on the Tasman Mill effluents in relation to mill process/treatment changes (1999-2004). (Diagram from van den Heuvel et al., 2008, used with permission). .....	30
Figure 2.1. Schematic dorsal view of the cephalic oculoscapular canal section of the defined canal morphotypes in common bully ( <i>G. cotidianus</i> ). Median pores (M), lateral pores (La = anterior, Lp = posterior), and primary neuromasts (pn). .....	43
Figure 2.2. Annual trends in female common bully gonadosomatic index (GSI). 45	
Figure 2.3. Annual trends in male common bully gonadosomatic index (GSI). ..	46
Figure 2.4. Mean ( $\pm$ SEM) female condition factor. ....	46
Figure 2.5. Mean ( $\pm$ SEM) male condition factor. ....	47
Figure 2.6. Mean ( $\pm$ SEM) female liver somatic index. ....	47
Figure 2.7. Mean ( $\pm$ SEM) male liver somatic index. ....	48
Figure 2.8. Mean ( $\pm$ 95% confidence interval) stable isotope ratios of carbon and nitrogen in common bully ( <i>G. cotidianus</i> ) from each sample site during the May and August (2007) sampling period. NT = 145. ....	49
Figure 2.9. Discrimination of diadromous from non-diadromous common bully ( <i>G. cotidianus</i> ) by ratios of $\text{Sr}^{88}/\text{Ca}^{43}$ and $\text{Ba}^{137}/\text{Ca}^{43}$ in the otolith nucleus... 55	
Figure 2.10. Reported distributions of common bully ( <i>G. cotidianus</i> ) in the Tarawera and Rangitaiki River systems by the New Zealand Freshwater Fish Database (NZFFD, NIWA, NZ). MD = Matahina dam. ....	57
Figure 3.1. Schematic of experimental choice chamber apparatus. ....	68

Figure 3.2. Proportion of common bullies (*G. cotidianus*) present in each chamber when subjected to varying effluent concentrations (A, B, C, D). Significant avoidance was exhibited at 100 and 50% effluent v/v ( $p = 0.00027$ , and  $p = 0.041$ , respectively). For the control (E) experiment, only reference river water was used, and the proportion of fish that moved to each choice chamber (left, right) or remained in the main chamber, was recorded. N = 20 fish per treatment..... 71

Figure 4.1. Mean hepatic ethoxyresorufin-*O*-deethylase (EROD) activity (pmol/resorufin/mg/min) in male and female common bully from the downstream Tarawera and the downstream Rangitaiki (reference). Error bars represent SEM; \* =  $p < 0.05$ . N<sub>Female</sub> = 11 (DT) and 14 (DR). N<sub>Male</sub> = 7 (DT), 4 (DR). ..... 90

Figure 4.2. In vitro steroid production of A) testosterone and B) estradiol from ovarian follicles. Steroid values are mean  $\pm$  SEM concentrations (pg/mg). N DT = 13, N DR = 10. All samples were carried out in duplicate..... 92

## List of Plates

Plate 1.1. The endemic New Zealand common bully ( <i>G. cotidianus</i> ).....	21
Plate 1.2. Upstream section of the Tarawera River (UT site) within the township of Kawerau.....	24
Plate 1.5. Coloured water in the downstream Tarawera River resulting from pulp and paper mill effluent discharge.....	25
Plate 1.6. The Tasman Mill in Kawerau, New Zealand.....	27
Plate 2.1. Fish collection through minnow trapping at the upstream Rangitaiki River site (UR), located close to the bottom of Matahina Dam (shown in the background).....	38
Plate 2.2. Laser ablation inductively-coupled mass spectrometer (ICP-MS) at the University of Waikato.....	41
Plate 2.3. Segment of common bully ( <i>G. cotidianus</i> ) otolith. Arrows point to laser ablation pits (diameter = 50 $\mu\text{m}$ , depth = 5 $\mu\text{m}$ ) located at the core, and edge of the otolith for microchemical analyses.....	41
Plate 2.4. Radiograph of the common bully ( <i>G. cotidianus</i> ) showing vertebrae..	44
Plate 2.5. Cephalic oculoscapular canal structure of the common bully ( <i>G. cotidianus</i> ). Defined canal morphotypes are shown in A-D (type 1 to type 4, respectively). Median pores (M), lateral pores (La = lateral anterior, Lp = posterior pores), and primary neuromasts (pn). Asterisks in (D) points to reduced anterior lateral pores. Circled in E, and F are unsymmetrical pore structure and deformed ‘split’ canals, respectively.....	51
Plate 3.1. Final treatment pond at the Tasman site.....	66
Plate 3.2. Effluent collection from the outfall of the final treatment system, Tasman site.....	66
Plate 4.1. Obtaining blood from common bully ( <i>G. cotidianus</i> ) through caudal venepuncture.....	81
Plate 4.2. Blood cell characterisation of common bully ( <i>G. cotidianus</i> ). Arrows point to; granulocytes (1,2), lymphocytes (3), and thrombocytes (clustered, spindle & rods) (4,5,6). All background cells are red blood cells (erythrocytes).....	88

# **Chapter One**

## **General Introduction**

## **1.1 General Introduction**

This thesis examines the ecology and physiology of wild common bully (*Gobiomorphus cotidianus*) populations in the Tarawera and Rangitaiki Rivers located in the Bay of Plenty Region of North Island, New Zealand. The Tarawera River is a heavily modified and degraded system that receives numerous industrial, municipal and natural inputs. Impetus for this research arose following unsuccessful attempts to assess the potential reproductive impacts associated with exposure to an industrial effluent within the river. These preliminary studies found differences in reproductive timing between exposed and unexposed populations, precluding the use of the upstream reference population for purposes of comparison. This thesis examined the reproductive timing and ecology of four populations within the Tarawera and Rangitaiki Rivers in order to subsequently examine the behaviour and relative health of common bully in the Tarawera River.

## **1.2 Anthropogenic impacts in large rivers**

Freshwater ecosystems may act as a sink for contaminants, receiving a variety of anthropogenic contaminants through point and non-point source pathways. Organisms within receiving environments may be subjected to a variety of associated stressors such as changes in physiochemical factors (temperature, salinity, and hydraulic regimes), increases in nutrients, changes in food and habitat, and exposure to contaminants (Adams & Greeley, 2000).

The use of biological indicators to evaluate the health of aquatic systems has long been recognised (Adams, 1990; McCarthy & Shugart, 1990). Fish in particular have been increasingly incorporated as a tool in the assessment of aquatic pollutants (Adams et al. 1993). Methods to investigate impacts and causal relationships have included controlled laboratory exposures, field microcosm or mesocosm exposures, field observations of exposure and response, mathematical stimulation monitoring, statistical associations and approaches, a combination of the previous approaches, and weight of evidence investigations (Adams, 2003). Standardised laboratory and mesocosm investigations are often applied where, for example, contaminant dose has been related to response of individual organisms, particularly at the biochemical or physiological levels. However, such

experiments usually expose fish to an effluent under highly controlled conditions, which seldom reflect the complexity of natural systems and lack ecological realism (Cairns, 1981).

Monitoring of wild populations *in situ* attempts to counteract some of these discrepancies by sampling species from their natural habitat and conducting a suite of physiological and biochemical measurements by which to assess longer-term effects of contaminants (Tremblay et al., 2005). Field studies have gained increasing importance as a means of determining the role of discharges in receiving waters from both a regulatory and research perspective (Dell et al., 1996).

### **1.3 Pulp and paper mill impacts**

The manufacture of pulp, paper, and paper products is one of the world's largest industries. A key aspect regarding the location of pulp and paper mills is a reliable water source. Large volumes of water are used within the production of materials, and in turn are responsible for the generation and disposal of significant quantities of effluent discharges to the aquatic environment (Ali & Shreekrishnan, 2001; Thompson et al., 2001). The quality and composition of these effluents vary between mills, depending on the manufacturing processes used, but often consist of complex chemical mixtures from combination of waste streams produced in debarking, pulping, bleaching and regeneration of cooking chemicals (World Bank, 1998). Untreated, these wastewaters are characterised by high biological oxygen demand (BOD), suspended solids (SS) and chemical oxygen demand (COD) (Pokhrel & Viraraghavan, 2004). Pulp and paper effluents contain complex chemical mixtures ranging from, but not limited to, resin acids and resin neutrals, phytosterols and chlorinated organic compounds such as dioxins, furans and other absorbable organic halides (AOX) (Pokhrel & Viraraghavan, 2004). Effluents are also generally high in nitrogen (N) as a result of N-fixing bacteria used in effluent treatment systems, phosphorous, and may contain traces of heavy metals. Combined raw effluents typically undergo primary and secondary treatment prior to discharge.

Previous years have focused on reducing the impacts of mill discharges on aquatic ecosystems (Owens, 1991; Axegård et al., 1997; Kovacs et al., 1997). The

global industry has invested billions of dollars toward research and technology aimed at reducing emissions and improving wastewater quality. Mill modernisation initiatives including more closed systems, introduction of elemental chlorine-free bleaching, and more efficient treatment of effluents have generally resulted in the decrease and eventual elimination of acute effluent toxicity shifting international research focus from acute effects to non-lethal or chronic effects of organism exposure (Shimp & Owens, 1993; Servos et al., 1996; Munkittrick et al., 1997; Dubé and McLatchy, 2000).

Despite general improvements in effluent quality and elimination of acute toxicity (Shimp and Owens, 1993), a variety of effects are still observed in both laboratory and field studies of fish exposed to many modern pulp and paper mill effluents to date (Kovacs et al., 2005; Parrot et al., 2006). Prominent sub-lethal and chronic responses associated with exposure include, but are not limited to, induction of hepatic detoxification enzymes (measured as fixed function oxygenase (MFO) activity and by EROD induction) (Munkittrick et al., 1994; Martel et al., 1996; Orrego et al., 2006; West et al., 2006), increased liver size (Forlin et al., 1995), changes in growth (Munkittrick et al., 1994), decreased gonad size (Munkittrick et al., 1992; Janz et al., 2001; Parrott et al., 2004), reduced fecundity (Rickwood et al., 2006), reduced sex steroid concentrations (Munkittrick et al., 1992; Dubé & MacLatchy, 2000; Dubé et al., 2002; Landman et al., 2008), modification of secondary sexual characteristics (Larson & Förlin, 2002; Ellis et al., 2003; Parrot et al., 2004), reduced stress responsiveness (McMaster et al., 1994), immunosuppression (Swanson, 1996; Forlin et al., 1995; Jokinen et al., 1995), mutagenicity and DNA damage (Janz et al., 1997; Lindesjoo et al., 2002).

#### **1.4 Migratory strategies in fishes**

Knowledge of residency and migratory life-history of fishes is critical in their effective use within an environmental indicator program, not only in terms of identifying exposure to contaminant sources, but also for understanding their distributions, abundance and ecological requirements (Gibbons et al., 1994; McDowall & Taylor, 2000). Diadromy is a specialised form of migratory behaviour in fish, which involves physiologically mediated movements between

marine and fresh waters (McDowall, 1987). Three distinct forms exist; catadromy, in which most feeding and growth occurs in freshwater prior to migration of adult fish to sea to reproduce (e.g. eels); anadromy, where most feeding and growth occur at sea prior to migration of adult fish into freshwater to reproduce (e.g. some salmonids); and amphidromy, in which migration is not for the purpose of breeding but occurs at some other regular phase of the life cycle. Adult amphidromous fishes live, breed and deposit eggs in freshwater reaches, their hatched larvae drift to the ocean for growth and development, and return back into freshwater as post-larvae (Joy et al., 2000). Whether diadromy is obligatory or facultative is highly species dependant. Some facultative species readily form land-locked populations, while others may form non-diadromous populations in waterways with unimpeded access to the marine environment. In the latter, whether or not to migrate is determined by individual state or environmental conditions (McDowall, 1997).

The distribution and upstream penetration of diadromous fishes within a system is influenced by species-specific migratory ability, instinctive drive and physical attributes of the waterway (Jellyman 1977; McDowall, 1990, 1993). Impediments to migration within a river may be natural or anthropogenic. Natural barriers may include waterfalls, swiftly flowing tributaries, or stream mouth closure (McDowall, 1993). Human-induced perturbations including dams (Joy & Death, 2000) and contaminants of various types such as sedimentation (Rabeni & Smale, 1995; Rowe & Deans, 1996; Boubee et al., 1997), low pH (McDowall, 1990), or nutrient/chemical discharges (McDowall & Eldon, 1980; Richardson, 1997) can also alter migratory patterns of fishes, limiting species distribution, and influencing community composition in unaffected waterways upstream. The New Zealand native freshwater fish fauna is distinctive in that many of the species may exhibit some form of diadromy (Joy et al., 2000). Diadromy is considered a primary factor in riverine fish distribution and impacts on many aspects of ecology, morphology and biogeography of the fauna (Hayes et al., 1989; McDowall, 1993).

## 1.5 The New Zealand freshwater Gobiidae

The New Zealand freshwater Gobiidae are comprised solely of the endemic *Gobiomorphus* genus, commonly referred to as the bullies. Bullies are demersal fish, with general features consisting of relatively small body size, stocky bodies with a blunted head, two dorsal fins, and a rounded tail (McDowall, 1990). There are seven known species of which includes the Cran's bully (*G. basalis*), Tarnedale bully (*G. alpinus*), upland bully (*G. breviceps*), common bully, giant bully (*G. gobioides*), bluegill bully (*G. hubbsi*) and the redfin bully (*G. huttoni*) (McDowall, 1990; McDowall & Stevens, 2007). Each can be differentiated according to certain anatomical and morphometric features such as colouration, scalation patterns, fin-ray counts and head pore structure. Further differentiation can also be inferred through various life-history strategies, with some being obligatory (redfin, giant, bluegill), facultative (common bully) or non-diadromous (upland, Cran's, Tarnedale) by completing their entire life cycle in freshwater systems (McDowall, 1990). Bullies are found in wide-ranging habitats. Many appear to be habitat generalists, yet others may be more specialised to specific habitat types (McDowall, 1990). For example, the giant bully typically occupies brackish/estuarine systems while the bluegill bully is well adapted for fast-flowing open water habitats in rivers and streams. Distribution patterns of each species relates well to those factors discussed above. Although the Cran's bully is fairly widespread in the North Island and the upland bully in the South Island, none are probably more ubiquitous than the common bully (Fig. 1.1).

The common bully (Plate 1.1) are perhaps the most well-known species within the bullies as they are widespread and abundant throughout New Zealand; occupying a wide variety of habitats including lakes, rivers, streams and wetlands (McDowall, 1990). This species is known to be facultatively diadromous, often leading to the establishment of physically and functionally landlocked or non-diadromous populations in water bodies with or without access to the sea (McDowall, 1990; Closs et al., 2003). During spawning, females of this species lay eggs on or under any hard surface. Eggs are fertilised and territorially defended by the male, which subsequently take on black nuptial colouring during this period. The common bully diet is typically carnivorous consisting of a variety

of benthic invertebrates, crustacea and small fish. Larval bullies are planktonic and feed on zooplankton (Rowe & Chisnal, 1996).

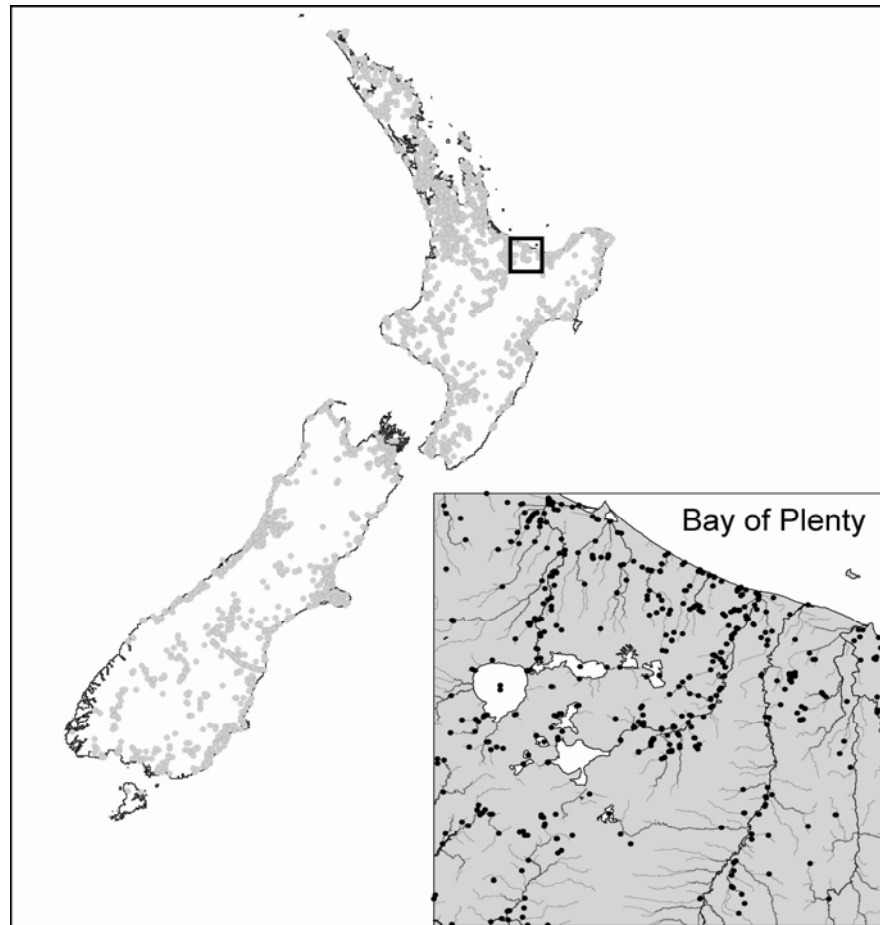

Figure 1.1. Common bully (*G. cotidianus*) distribution throughout New Zealand recorded by the New Zealand Freshwater Fish Database (NZFFD), NIWA (<http://www.niwa.cri.nz/services/free/nzffd>).

### *1.5.1 Sentinel species for pollution monitoring*

Small-bodied fishes has established as important indicator species in monitoring the impacts of anthropogenic discharges within the aquatic environment (Gibbons et al., 1994, 1998). The effective use of freshwater fishes as bioindicators requires that the organism fulfils a number of criteria as described by Tremblay et al. (2005). Of high importance is that the target species is resident or exposed to site conditions long enough to elicit biological responses. The small size, benthic nature and site fidelity (presence of adults) of the common bully

contributes to meeting this criterion as their home ranges and migrations are correspondingly smaller than those of larger fish species. The chosen species must also be present in sufficient number at a site to allow for efficient capture of statistically robust sample sizes without impacting the population; must not be subject to commercial exploitation as this may minimise the ability to detect impacts of pollution; and must have a wide geographical range to facilitate comparisons between regions (Tremblay et al., 2005). Fitting all of the above criteria, the common bully has been utilised as an effective biomonitoring species in a number of recent wild population field assessments (Tremblay et al., 2005; West, 2006; Landman & Ling, 2006; Landman et al., 2007), including some studies of pulp and paper effluent exposure (West, 2006, van den Heuvel et al., 2007; Landman et al., in press).



Plate 1.1. The endemic New Zealand common bully (*Gobiomorphus cotidianus*).

## 1.6 Study Site

The study sites for this investigation were the Tarawera and Rangitaiki Rivers located in the Bay of Plenty Region of the North Island, New Zealand. Site locations, including the geographic co-ordinates, are presented in Fig. 1.2.

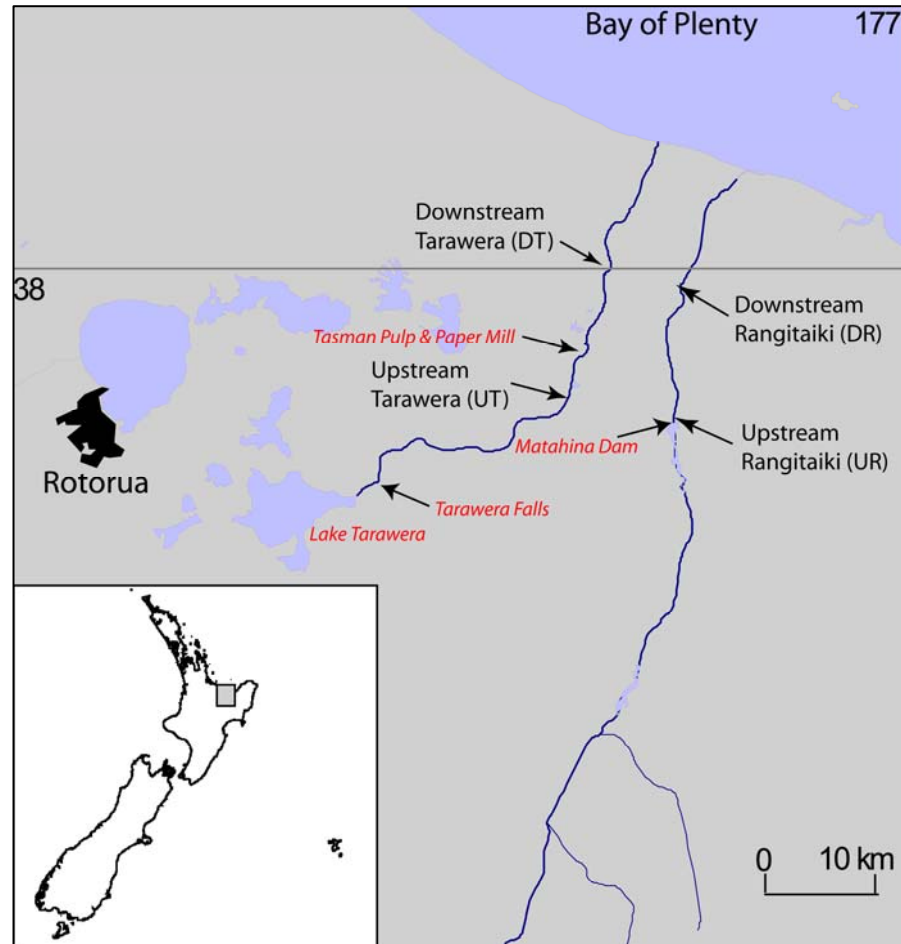

Figure 1.2. Map of site locations in the Tarawera and Rangitaiki Rivers, Bay of Plenty, New Zealand. Latitude and longitude for sample locations are as follows; Upstream Tarawera (UT = 38°06' 12.2" S, 176° 42' 14.1" E; Downstream Tarawera (DT = 38° 01' 22.5" S, 176° 44' 18.5" E); Upstream Rangitaiki (UR = 38° 06' 47.9" S, 176° 48' 46.3" E), and Downstream Rangitaiki (DR = 38° 00' 11.2" S, 176° 49' 06.0" E).

### 1.6.1 The Tarawera and Rangitaiki Rivers

Originally the Tarawera and Rangitaiki rivers were partially joined through an extensive wetland area which covered much of the Rangitaiki plains (Park & Wilding, 1998). During the early 1900's these rivers were channelised and straightened. This resulted in considerable scouring and a decline in fish habitat in the lower section of these rivers.

The Tarawera River has a catchment area of 984 km<sup>2</sup> and originates from the oligotrophic Lake Tarawera<sup>1</sup>. The river travels a distance of approximately 55 km to the coast at Matata where it enters the Pacific Ocean. Historical mean river flows have been measured at 26 m<sup>3</sup>/s (Rutherford, 1997). The flow regime of the river is kept relatively stable owing to the combined effects of the lake reservoir-effect and the highly permeable pumice soils of the region reducing surface runoff (Dell et al., 1996).

The upstream reach of the Tarawera River (Plate 1.2) is characterised by high water quality supported by high dissolved oxygen concentration, low water and sediment biological oxygen demand, and high visual clarity of the water (Plate 1.3) (EBOP, 2004). Land use in the upstream reaches of the river consists of predominately native and exotic forests, with very little human habitation (Rutherford, 1997). In contrast, the downstream Tarawera River has been heavily modified following the wetland drainage, river diversion and straightening. Downstream of the Kawerau Township (Plate 1.4), located approximately 30 km inland from the sea, the Tarawera River previously received a combination of natural, municipal and industrial inputs including an integrated pulp and paper mill, a tissue paper mill, sewage plant and a geothermal bore field. Combined effluents from the pulp and paper mills represent the most significant discharges by volume, accounting for 10-15% of mean river flow downstream of the outfall (Nick Eynon-Richards, CHH Tasman Environmental Manger, pers. comm.). Effluent loading results in significant discolouration (Plate 1.5), increased temperature, reduced dissolved oxygen (DO), and increases chemical and microbial contaminants.

The Rangitaiki River runs parallel to the Tarawera River. It is a larger river with a total length of 155 km, a mean flow rate of 70 m<sup>3</sup>/s, and a total catchment area of 3005 square km<sup>1</sup>. The headwaters of the Rangitaiki originate in the central volcanic plateau within the Kaingaroa ecological district, and the river exits the coast at Thornton. The river has been hydrologically modified by the construction of two hydroelectricity dams (Matahina and Aniwhenua) located along its mid section. Land use within the Rangitaiki catchment is dominated by

---

<sup>1</sup> Environment Bay of Plenty; <http://www.ebop.govt.nz/Water/Rivers/Rangitaiki-Tarawera-Rivers-Scheme.asp>



Plate 1.2. Upstream section of the Tarawera River (UT site) within the township of Kawerau.



Plate 1.3. High visual clarity in upstream Tarawera River.



Plate 1.4. Downstream section of the Tarawera River (DT site).



Plate 1.5. Coloured water in the downstream Tarawera River resulting from pulp and paper mill effluent discharge.

agriculture, particularly dairy farming, contributing to diffuse non-point source nutrient inputs along the river.

### *1.6.2 Pulp and Paper Mill Descriptions*

Until recently, there were two separate pulp and paper mills operating alongside the Tarawera River discharging effluents either directly into the river or to river-adjacent rapid infiltration basins (RIBs). The largest mill is an integrated bleached kraft pulp mill and thermomechanical pulp and paper mill, hereafter referred to as the Tasman Mill. The Tasman Mill is operated as a joint-venture between Norske Skog and Carter Holt Harvey (CHH) Pulp and Paper. The CHH kraft pulp mill produces approximately 300 and 500 T/d of unbleached and bleached pulp, respectively. The Norske Skog mill produces 900 T/d of mechanical pulp and 1000 T/d of newsprint paper. Mill furnish is predominantly softwood (*Pinus radiata*), with occasional pulping of *Eucalyptus* species.

The Tasman Mill (Plate 1.6) has been elemental chlorine free (ECF) since April 1998. Kraft pulp now undergoes treatment with sodium hypochlorite or chlorine dioxide. Thermo-mechanical pulp effluent is pre-treated within an activated sludge bioreactor system before combination with the kraft pulp mill effluent. The combined effluents are primary treated by passage through a gravity clarifier which removes solid waste. Secondary treatment is through an aerated pond system with a residence time of 4-5 d, after which the effluent is discharged directly into the Tarawera River at a rate of approximately 130,000 m<sup>3</sup>/d. The dilution of this effluent into the Tarawera River ranges between 10-15%.

The second mill is the Svenska Cellulosa Aktiebolaget (SCA) Hygiene Australasia tissue mill (formally Carter Holt Harvey Consumer Brands). The SCA tissue mill historically produced approximately 110 T/d of unbleached and peroxide bleached chemi-thermomechanical pulp (CTMP) and 160 T/d of tissue paper. Pulp mill wastewater in combination with Kawerau municipal sewage was treated via an anaerobic system, and discharged between 6,000 and 8,000 m<sup>3</sup>/d of effluent both directly to the river and to the RIBs. Grey water from the paper making process is passed through a clarifier and sent to the Tasman Mill secondary treatment system. It is noteworthy that prior to 1999 this effluent was

discharged directly to the river. The combined total water usage of the mills, taken from the Tarawera River daily is approximately 110-115,000 m<sup>3</sup>/d.

Production of pulp by the SCA tissue mill was terminated in May 2007, therefore effluent from the pulping process is no longer produced. Treatment of sewage is now managed by the Kawerau District Council (KDC) but continues to be discharged via a new set of RIBs.



Plate 1.6. The Tasman Mill in Kawerau, New Zealand.

## **1.7 An overview of recent biota monitoring**

### *1.7.1 Tarawera River fisheries monitoring*

Extensive research has been conducted over the past two decades to assess potential biotic impacts of pulp and paper mill discharges on the Tarawera River. Early studies examined fish community assemblages in the river and established similar fish densities between the Tarawera and adjacent Rangitaiki River (Park & Wilding, 1998). However, the diversity of indigenous species in the river has been reported to be much lower than other rivers in the Bay of Plenty area (Young & Griffith, 1999). A survey by Park (2001) revealed an absence of previously recorded fish in the Tarawera such as koaro (*Galaxias brevipinnis*), giant kokopu

(*Galaxias postvectis*), inanga (*Galaxias maculatus*) and lamprey (*Geotria australis*), raising concerns about poor water quality in the lower Tarawera due to effluent loading and/or reduced DO (Young, 2002). Although the regulatory limit for BOD of released effluents is 6 mg/L, DO fluctuations have been commonly reported in the river downstream of the mill outfall, especially during the summer months (Taylor & Park, 2001). Accordingly, several recent studies followed investigating the effects of varying DO levels in fish (Young, 2002; Landman, 2004). Caging studies were carried out in the Tarawera River on juvenile koaro and inanga to examine *in situ* effects of downstream effluent exposure and DO on fish survival (Young, 2002). Results of the inanga study did not show any significant differences in survival between the exposed Tarawera fish compared to caged reference fish in the Rangitaiki River. However, during the course of the koaro study, DO levels of exposed sites regularly fell below 5 mg/L, and a tentative relationship between mortality and reduced DO was found. A collection of studies outlined by Landman (2004) are described in more detail in the following section.

#### *1.7.2 Pulp and paper effluent environmental effects assessments*

Since the late 1990s many investigations have continued to focus on sub-lethal and chronic effects of effluent exposure utilising a variety of fish species and exposure methods. This body of research has helped to form part of a larger worldwide effort to understand the more subtle effects of pulp mill effluents.

A series of controlled mesocosm studies using rainbow trout (*Oncorhynchus mykiss*) observed numerous alterations in reproductive physiology associated with the Tasman Mill effluent. In a 2-month study which exposed reproductively-maturing trout to 10% final effluent, fish exhibited slight induction of hepatic 7-Ethoxyresorufin-*O*-deethylase (EROD) enzyme activity (van den Heuvel et al., 2002). No effects were observed on growth, gonad development or circulating sex steroid concentrations compared to river water exposed control subjects. However, follow-up studies revealed that reproductive effects were only manifest when exposure was initiated before to the onset of gonadal maturation, indicating that timing of exposure was important (van den Heuvel & Ellis, 2002). In this study adult trout, roughly 3 months prior to gonadal development were

exposed to 12% effluent for 8 months. Results showed a reduction in growth of both sexes, females had lowered plasma levels of circulating sex steroid concentrations, and reduced ovary size coinciding with smaller fry at swim-up. Males showed induction of vitellogenin (the egg-yolk precursor protein) and lowered 11-ketotestosterone levels. Similar effects were not observed in fishes exposed to 12% effluent for a two month period, starting approximately halfway through gonadal maturation. Subsequent experiments indicated the disappearance of many of the reproductive effects and EROD induction in rainbow trout (van den Heuvel et al., 2004). Experiments which exposed juvenile rainbow trout to this effluent also failed to show reductions in plasma sex steroids or vitellogenin induction (Ellis et al, 2004).

The androgenic potential of this effluent has been demonstrated in the past. Twenty one day laboratory exposures of mosquitofish (*Gambusia affinis*) to both untreated and secondary-treated Tasman Mill effluent caused masculinisation of females through expression of pseudo-gonopodial development and male-like mating behaviours (Ellis et al., 2000; 2003). Filtration of effluent eliminated the masculinisation effects, indicating that active components causing the observed effects were associated with suspended solids. However these effects have subsequently disappeared (van den Heuvel et al., 2004). A summary of fish assessment work conducted on these effluents between 1999 and 2004 is presented in Fig. 1.3.

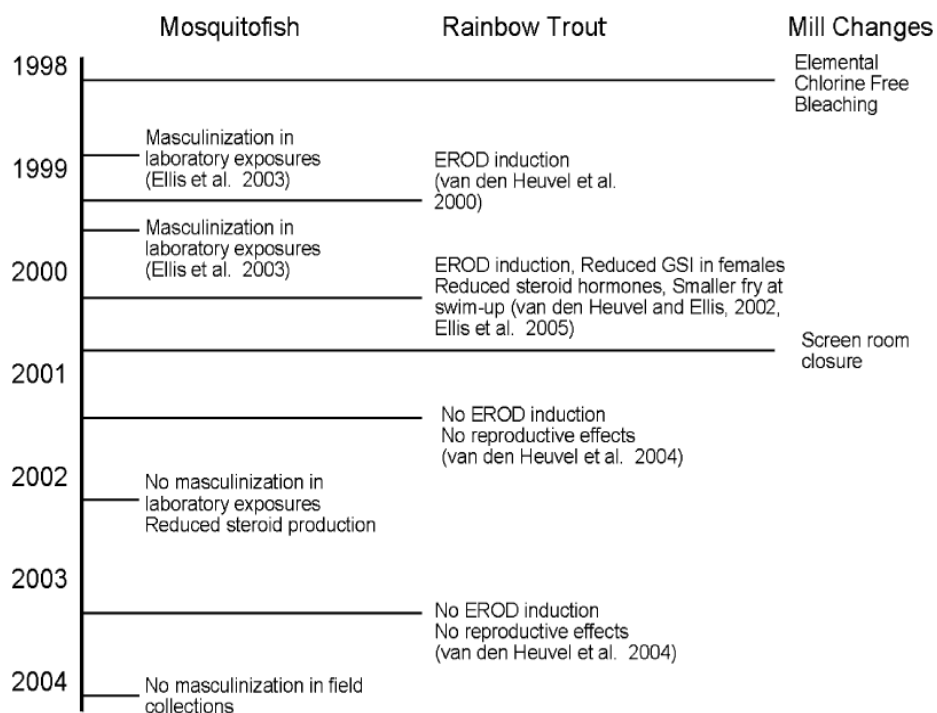

Figure 1.3. Summary of fish exposure assessments based on the Tasman Mill effluents in relation to mill process/treatment changes (1999-2004). (Diagram from van den Heuvel et al., 2008, used with permission).

In order to further explore the concerns raised by Young (2002) regarding the possible interactions between mill effluent exposure and reduced dissolved oxygen concentrations, a number of studies were subsequently performed (Landman 2004; Landman et al., 2004, 2005, 2006). Initial acute lethality experiments utilising larval/fry and juvenile life-stages of rainbow trout and common bully examined the relative sensitivities (48-h LC50) of these organisms to the simultaneous exposure of effluent within a range of dissolved oxygen concentrations (Landman et al., 2004). In this study, significant relationships between species life-stage or between effluent and control exposures were not observed. Sub-chronic (1 week – 1 month) juvenile rainbow trout exposures demonstrated some limited effects on basal oxygen consumption (Landman et al., 2004), general haematology and swimming performance (Landman et al., 2006). However, these effects were either small in magnitude, typical of hypoxia exposure, or at occurred at environmentally unrealistic effluent concentrations (i.e. 70% v/v effluent). This lead Landman (2004) to conclude that dissolved

oxygen and effluent interactions were not a problem within the Tarawera River, provided that river oxygen concentrations remained above the current regulatory limit of 6 mg/L.

While controlled laboratory and mesocosm exposures established elimination of significant effects over time, a recent *in situ* field experiment contradict these findings. Caged shortfin eel (*Anguilla australis*) exposed within the Tarawera River below the influence of mill discharges for a 21-d period expressed continuation effluent-associated effects including reduced condition factor, elevated sex steroid concentrations, EROD induction and accumulation of pyrene and retene equivalents in bile extract compared to eels caged upstream (van den Heuvel et al., 2006). These authors' suggest that the discrepancy between mesocosm and river studies was likely related to the presence and exposure of eels to contaminant-laden sediments *in situ*. This study highlighted shortcoming of controlled laboratory and mesocosm studies that often fail to factor the complexity of natural systems, and concern was raised for wild fish populations within the river.

### *1.7.3 Monitoring wild common bully populations in the Tarawera River*

Recently, an attempt was made to assess the potential long-term impact of mill discharges on wild resident common bully within the Tarawera River (van den Heuvel et al., 2007). This study compared a downstream effluent-exposed population to an upstream reference site and observed differences in reproductive timing between the two populations precluding use of the upstream population for the purposes of comparison. Genetic analyses confirmed the two populations were genetically distinct despite short distances between sample sites suggesting reproductive isolation in the absence of physical barriers to migration (van den Heuvel et al., 2007, Michele et al., 2008). Otolith microchemistry and morphological variation also indicated a potential loss of diadromy in the upstream fish population. Further work identified a common bully population within the adjacent Rangitaiki River as having similar developmental reproductive period and genetic similarity to the downstream Tarawera bullies, indicating such factors were not site-specific, and recommended this population as a more ecologically relevant reference in future impact assessment.

Collectively, three unanswered questions were raised;

- Is reproductive divergence and loss of diadromy in Tarawera common bully related to the pulp mill influence or inland distance?
- Does the pulp and paper mill effluent act as a chemical barrier in migratory fish behaviour?
- What, if any, are the long-term effects of pulp and paper mill discharges on wild resident common bully health within the Tarawera River?

### **1.8 Research aims**

Accordingly, the objectives of this thesis were threefold;

1. Firstly to determine spawning season, residency, diadromy and morphology of upstream and downstream Tarawera River common bully populations, and compare and contrast those findings to associated sites on the Rangitaiki River
2. Secondly to conduct a behavioural assessment to determine avoidance reaction of common bully to concentrations of pulp and paper mill effluent
3. And thirdly, to conduct an impact assessment to investigate reproductive and physiological impacts of long-term exposure to the pulp mill effluent on resident, wild common bully populations within the downstream Tarawera River, using the recommended Rangitaiki reference site as a comparison.

## **Chapter Two**

**Ecology of common bully in the Tarawera and Rangitaiki Rivers**

## 2.1 Introduction

Diadromy is a life history strategy exhibited in some fish species involving the migration between freshwater and the sea (McDowall, 1988, 1992). A loss of this migratory behaviour may occur in normally diadromous populations which have become landlocked, either by a natural process (i.e. stream mouth closure) or through anthropogenic influence (i.e. barriers, pollutants) (McDowall & Eldon, 1980; McDowall, 1993; Joy & Death, 2000). Some species may be facultatively diadromous, appearing to voluntarily choose to abandon the migratory phase even in systems that have open and unimpeded access to the sea (Northcote & Ward, 1985; McDowall, 1988, 1988; Closs et al., 2003).

Analysis of otolith (ear bone) microchemistry enables the direct measurement of fish life histories. Paired otolith are comprised predominately of aragonitic calcium carbonate ( $\text{CaCO}_3$ ) that grow continuously from the earliest natal stage through to adulthood (Campana, 1999). Dissolved trace elements from the water are incorporated into the otolith as it grows, and although the rates of uptake are influenced to some degree by factors such as temperature, salinity, food and exposure time (Radtke & Shafer, 1992; Elsdon & Gillanders, 2002, 2005a, b; Buckel et al., 2004), the relative concentrations of trace elements from core to edge can generally be used to reconstruct the ambient water chemistry during different stages of ontogeny (Radtke & Kinzie, 1996). Seawater typically has relatively high and uniform concentrations of strontium, whereas freshwater is often enriched with barium (Campana, 1999). The ratio of these elements to calcium in the otolith can therefore be used to track movements between freshwater and marine environments permitting discrimination between diadromous and non-diadromous ecotypes (Secor & Rooker, 2000; Gillanders, 2005). With the development of highly sensitive techniques such as laser ablation inductively coupled mass spectrometry (LA-ICPMS), the concentrations of these trace elements can now be routinely quantified.

The loss of marine migration has been implicated as a main factor driving intraspecific diversification between diadromous and non-diadromous stocks of species (e.g., Allibone & Wallis, 1993; McDowall, 1998, 2001). Morphological and meristic divergence has been reported in association with loss of diadromy. Examples of this include changes in body size (Chapman et al., 2006), fin-ray

counts (Humphries, 1990), gill rakers (Ward et al., 2005), vertebral counts (McDowall, 1972a, b, 1979, 1988, 2003) and cephalic oculoscapular canal formation (McDowall, 1990; Michel et al., 2008). Vertebral number has also been employed as a diagnostic feature in fish taxonomy where a relationship between vertebral count and life-history strategy has been observed (McDowall, 2003a, b; Ward et al., 2005; Barriga et al., 2007). Increased numbers of vertebrae have been associated with diadromous fish compared to fewer vertebrae in non-diadromous populations of the same species (McDowall 1972a, b, 1979, 1988; McDowall and Frankenburg, 1981). Diadromous New Zealand common smelt (*Retropinna retropinna*) possess between 58 to 63 vertebrae, while their freshwater fluvial counterparts typically possess reduced numbers of vertebrae ranging from 49 to 60 (McDowall, 1972a, b, 1979 ). A similar phenomenon has also been described for some galaxiid species (Barriga et al., 2007). The functional or adaptive significance of vertebral variation is poorly understood. McDowall (2003) suggested that the relationship between higher vertebrae number and size of marine juveniles implies a selective advantage for higher vertebral counts, and thus larger larvae in the marine environment.

Changes in the peripheral lateral line system in association with life history have been suggested in some gobiid species (McDowall, 1990). The morphology of the lateral line is thought to have evolved in response to varying levels of background flow in the environment (Coombs et al., 1992). The mechanosensory lateral line system in fish is primarily used in prey detection and predator avoidance, and is composed of two types of receptors; superficial neuromasts which are velocity detectors located at the surface of the skin, and canal neuromasts which are pressure gradient detectors and located within sub-epidermal fluid-filled canals (Coombs et al., 1988; Modgans, 2005). Generally, fish inhabiting fast flowing environments exhibit an extensive canal system and a reduction in superficial neuromasts, and vice versa for fish inhabiting slow flowing environments. The various degrees of reduction, or complete loss of canal neuromasts and a proliferation of superficial neuromasts in many gobiids, including some river stocks, is thought to be an adaptation to distinct microhabitats with slow flowing conditions (Modgans, 2005). However, other studies have shown that canal structure can be at least partly inherited (Ahnelt et al., 2004). Canal structure in the goby-like New Zealand common bully

(*Gobiomorphus cotidianus*) is highly variable and differences between amphidromous and non-amphidromous stocks have been described (McDowall, 1990; Michel et al., 2008). McDowall (1990) speculated that the gradual reduction or absence of canal pores within fluvial lake stocks might be the result of landlocking. This view is perhaps supported by the existence of three exclusively fluvial *Gobiomorphus* species; Cran's bully (*G. basalis*), Tarndale bully (*G. alpinus*) and upland bully (*G. breviceps*). These species do not possess cephalic lateral line canals, whereas the obligatory amphidromous redbfin (*G. huttoni*), giant (*G. gobioides*) and bluegill (*G. hubbsi*) bullies exhibit complete canal formations (McDowall, 1990).

Of the seven endemic *Gobiomorphus* species, only the common bully is known to be facultatively amphidromous (McDowall, 1990; Closs et al., 2003). The life cycle strategy of amphidromous common bully involves the spawning of adults in freshwater, with hatched larvae drifting to sea where they spend 2-3 months before migrating back into freshwater as post larvae/juveniles (McDowall, 1990). Non-diadromous fluvial common bullies complete their entire life cycle in freshwater. High flexibility in this life strategy no doubt contributes to the widespread distribution and inland penetration of this species. Non-diadromous landlocked populations of common bully have been reported up to 300 km inland (NZ Freshwater Fish Database, NIWA), while amphidromous riverine populations have been reported only up to 50 km inland (Closs et al., 2003). In general, non-diadromous fish tend to dominate with greater inland distance from the sea (McDowall, 1998).

Otolith microchemistry has been used to determine the migratory history of common bully in New Zealand and using this technique, Closs et al. (2003) recently reported the co-existence of amphidromous and non-amphidromous populations in coastal river systems with open access to the sea. It was suggested that this species may choose to abandon the marine migratory phase if appropriate larval and juvenile rearing habitats are available. Recent studies by van den Heuvel et al. (2007) and Michel et al. (2008) reported the existence of distinct migratory and non-migratory common bully ecotypes within a geographically confined range of the Tarawera River. Associated with a loss of the marine migratory stage was variation in genetic structure, morphology and reproductive timing, reflective of characteristics more commonly observed in non-migratory

bully species (McDowall, 1990). Populations from the upstream and downstream Tarawera River were compared to a landlocked Lake Tarawera population and to an outgroup population from the lower Rangitaiki River. Otolith microchemistry revealed a predominance of amphidromous bullies in the two downstream river reaches. A distinct lack of diadromous recruitment was evident in the upstream Tarawera population despite no known physical barrier to migration, although possible chemical barriers were identified.

The Tarawera River originates from Lake Tarawera, formed by lava streams approximately 10,000 yrs ago (Healey, 1962.). Approximately 2 km from the lake outlet, the Tarawera Falls represent a significant barrier to upstream movement into the lake. However, the possibility of downstream transport of fish to the river remains. Common bully from the Waikato River were introduced into Lake Tarawera in the early 1900s as forage food for trout after a series of volcanic events depleted the native fish fauna (Burstall, 1980). Through analysis of amplified fragment length polymorphism (AFLP) fingerprints, van den Heuvel et al. (2007) and Michel et al. (2008) demonstrated some degree of genetic isolation between the migratory and non-migratory stocks in the Tarawera River. These authors have suggested that the genetic similarity between the upstream Tarawera and Lake Tarawera common bully populations may indicate that fish in the upstream river may have originated as larval lake washouts and therefore inheriting the predisposition for non-migratory type and canal structure. Temporal differences in reproductive timing (migratory winter spawners *vs.* non-migratory summer spawners) suggests a prezygotic reproductive isolation mechanism between the two ecotypes and a reduction of oculoscapular canals in non-diadromous fish has also been noted.

The objective of the current study was to determine if a lack of diadromous recruitment to the upstream Tarawera River was associated with inland distance or some other influencing factor in the river. If solely due to inland distance, it was hypothesised that a similar divergence of migratory types would be observed in the adjacent Rangitaiki River. Additionally, this study sought to identify and compare morphological and reproductive variation associated with a loss of diadromy in these river systems.

## 2.2 Materials and Methods

### 2.2.1 Sampling sites and fish capture

Bimonthly collections of common bully (*Gobiomorphus cotidianus*) were undertaken between January and December 2007 in the Tarawera and Rangitaiki Rivers. Paired upper and lower river sites were selected (Chapter 1, Fig. 1.2). The Tarawera River sites were chosen to represent an upper, undisturbed site at the Kawerau Township (UT) and a downstream pulp mill-impacted site at Otakiri (DT). Inland river distances for these sites were 37 km and 20 km, respectively. The Rangitaiki River sites roughly matched the inland distance for the Tarawera River sites. The upper Rangitaiki site (UR) was 40 km inland, immediately below the Matahina Dam (Plate 2.1), and the lower site between Te Teko and Edgecumbe (DR) was 17 km inland. Approximately 20 fish (10 male, 10 female (NT = 590)) per site and sampling period were captured using minnow traps set overnight (LT, LR, UR) or by evening spotlight and dip-netting (UT).

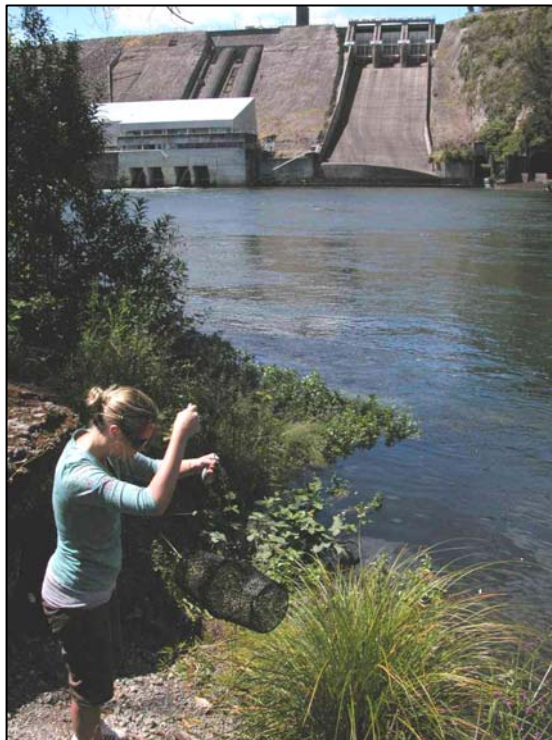

Plate 2.1. Fish collection through minnow trapping at the upstream Rangitaiki River site (UR), located close to the bottom of Matahina Dam (shown in the background).

### *2.2.2 Sampling protocol*

Fish were sacrificed by anaesthetic overdose (0.1 g/L MS-222, Sigma-Aldridge) prior to necropsy. Each fish was individually measured for body weight ( $\pm 0.01$  g), total length ( $\pm 1.0$  mm), organ mass (liver and gonad;  $\pm 0.001$ g) and carcass weight ( $\pm 0.01$  g). Carcasses were stored frozen at  $-20^{\circ}\text{C}$  in labelled Whirl-Pak<sup>TM</sup> bags (Nasco, USA) pending analysis of stable isotopes, otolith microchemistry and vertebral counts.

### *2.2.3 Tissue stable isotope analysis*

Stable isotope analyses were performed on 20 fish (10 male, 10 female) from each site capture during the May and July sampling periods ( $n = 160$ ) to establish residency and site fidelity. Skinless segments of white muscle of approximately 1 g were taken from the dorsal side of each fish and freeze-dried. Dried tissue samples were ground into a fine powder with a mortar and pestle and stored in sealed cryo-vials until analysis. Stable isotopes of carbon and nitrogen were analysed at the Waikato Stable Isotope Unit (Waikato University, Hamilton, NZ) on a fully automated Europa Scientific 20/20 isotope analyser according to the method of Hicks et al. (2005).  $\delta^{13}\text{C}$  results have a precision of  $\pm 0.1\text{‰}$  and were compared to a pre-calibrated C4-sucrose cross-referenced to Pee Dee belemnite.  $\delta^{15}\text{N}$  results have a precision of  $\pm 0.3\text{‰}$  and were compared to a urea standard that is traceable to atmospheric nitrogen (Hicks et al., 2005).

### *2.2.4 Otolith microchemistry*

Otolith microchemistry was conducted on approximately 12-15 fish from each of the four sites ( $n = 55$ ). Left sagittal otoliths were extracted from individual fish by cutting along the dorsal midline of the braincase. Each otolith was cleaned in deionised water, air dried for 24 h at room temperature and then horizontally mounted, sulcus-side down, onto glass slides using Crystalbond thermosetting glue (Aremco Products Inc., USA). Slide-mounted otoliths were ground and polished to the nucleus using a series of wetted carborundum papers (2000 and

4000 grade, respectively). Core nucleus exposure was identified using light microscopy at 40x magnification.

Sr/Ca and Ba/Ca ratios were measured for the core and edge of each otolith using laser ablation inductively-coupled plasma mass spectrometry (LA-ICPMS). The measurements were carried out using a New Wave UP 213 (213 nm:YAG) laser ablation system and a Perkin Elmer Elan SCIEX DRCII ICPMS at the Waikato University Department of Chemistry Mass Spectroscopy Suite (Plate 2.2). The LA system had a helium aerosol carrier gas system which enhanced sensitivity through increased production and transfer of ablated particles to the ICP-MS (Swearer, 2000; Zacherl et al., 2003). Otoliths were placed in the sample cell and the central nucleus and edge were located for spot analysis at 400x magnification with a video imaging system. Experimental conditions for the laser and ICPMS system were optimised according to the sample size. Laser spot size varied from 40-50  $\mu\text{m}$  diameter (Plate 2.3) depending on otolith size, and to a depth of 5  $\mu\text{m}$  with a 5 Hz repetition rate. Laser power was set at 55% output with a 40 s firing. Between samples the ablation chamber was purged for 90 s with argon gas. Additionally, the laser was fired at 0% power to standardize against interferences from the carrier gas. The elemental standard used was a NIST 612 glass (National Institute of Standards and Technology, USA) included within the sample cell.

Data from the ICP-MS was transferred into the Glitter software program (GEMOC/CSIRO, 1999, 2000) for data display and analysis. Control measurements were subtracted from sample counts per second (cps) to overcome any polyatomic interference. Isotope ratios were calculated from peak cps for each otolith. Results are presented as dimensionless units for each isotope standardised to counts of  $^{43}\text{Ca}$ , an accepted technique in the absence of matrix-matched standards (Morales-Nin et al., 2005).

To correlate otolith results with ambient environmental exposure of fish, seasonal water samples were collected from all river sampling sites, as well as coastal seawater samples (~ 3.2 km offshore) obtained by Environment Bay of Plenty (EBOP, Whakatane, NZ) personnel. On arrival at the laboratory, seawater samples were diluted 1000-fold to avoid salt saturation of the ICP-MS. River and seawater samples were individually filtered (0.45  $\mu\text{m}$ ) and ultrapure nitric acid (Scharlau AC1613) added to a final concentration of 2%. Samples were

refrigerated (4°C) and stored in the dark pending analysis. Samples were analysed for 28 elements (Li, B, Na, Mg, Al, P, K, Ca, Cr, Fe, Mn, Co, Ni, Cu, Zn, As, Se, Sr, Ag, Cd, In, Ba, La, Hg, Tl, Pb, Bi, U).



Plate 2.2. Laser ablation inductively-coupled mass spectrometer (ICP-MS) at the University of Waikato.

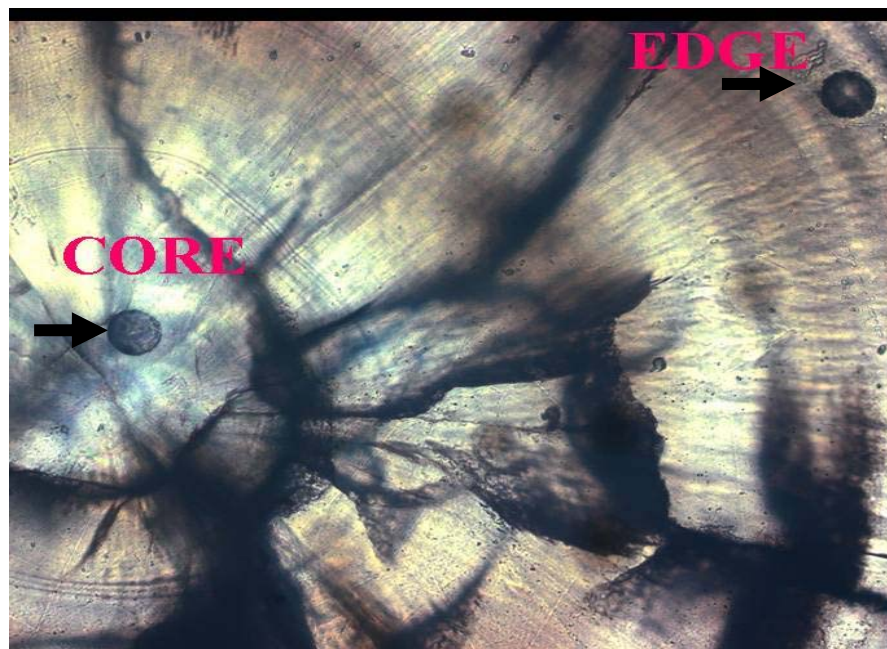

Plate 2.3. Segment of common bully (*G. cotidianus*) otolith. Arrows point to laser ablation pits (diameter = 50  $\mu\text{m}$ , depth = 5  $\mu\text{m}$ ) located at the core, and edge of the otolith for microchemical analyses.

### *2.2.5 Identification of canal morphotypes*

Morphological analyses on the supraorbital section of the oculoscapular canals was conducted on a total of 227 fish under a stereo microscope. Canal morphotypes were distinguished according to Michel et al. (2008) with the addition of a further canal configuration and classified into four categories (Fig. 2.1). Type 1 was characterised by paired median pores as well as anterior and posterior lateral pores; Type 2 had reduced median pores and hence only anterior and posterior lateral pores present; Type 3 lacked any oculoscapular pores but possessed a continuous pattern of very fine papillae ranging from the nasal to eye area; and Type 4 had medium pores present but lateral pores absent. Canal types were recorded individually and proportions of canal types among the four sampling locations were calculated.

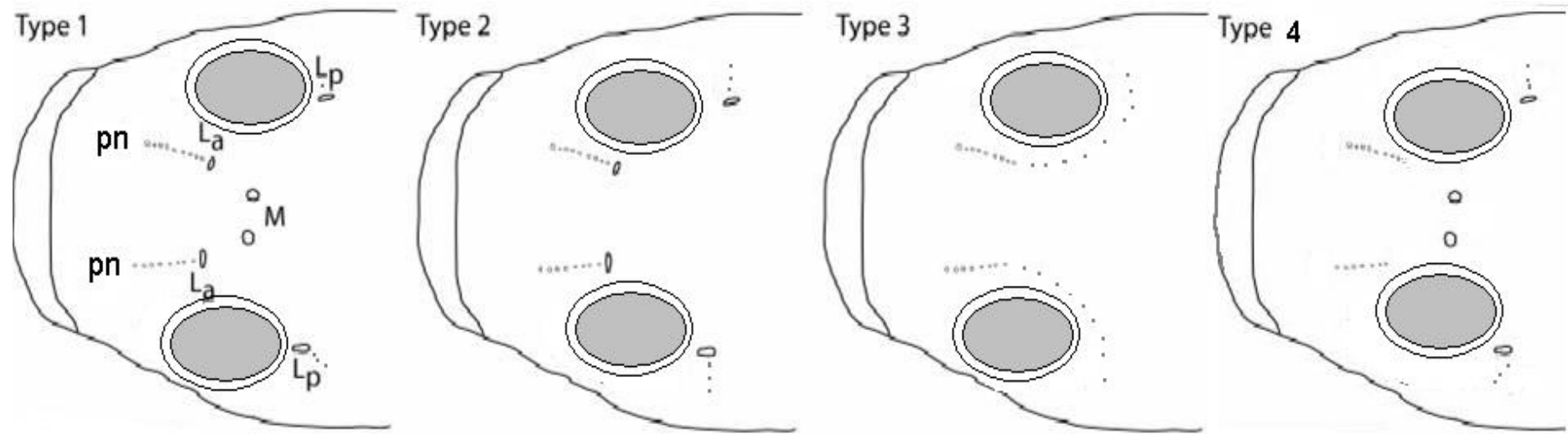

Figure 2.1. Schematic dorsal view of the cephalic oculoscapular canal section of the defined canal morphotypes in common bully (*G. cotidianus*). Median pores (M), lateral pores (La = anterior, Lp = posterior), and primary neuromasts (pn).

### 2.2.6 Vertebral counts

Approximately 20 fish from each site were fixed onto flat, non-corrugated cardboard and x-rayed at Angelsea Woman's Health (Hamilton, NZ) using a high-resolution mammography machine. The vertebral count of fish was individually determined from the resulting radiographs (Plate 2.4) under a stereo microscope. Counts included all vertebrae except the hypural plate.

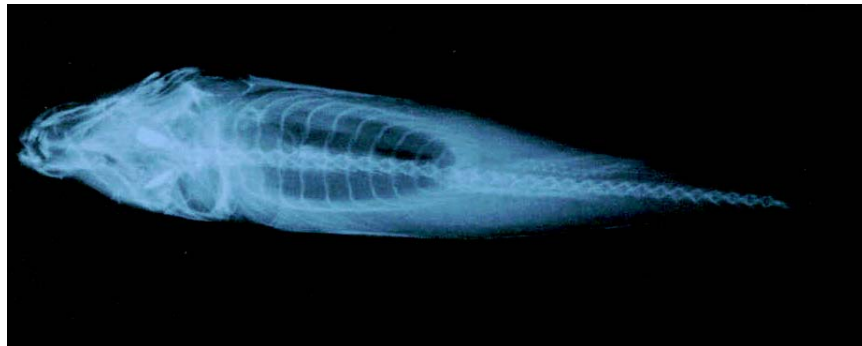

Plate 2.4. Radiograph of the common bully (*G. cotidianus*) showing vertebrae.

### 2.2.7 Statistical analysis and calculations

Condition factor = (fish mass - organ mass)/(total length<sup>3</sup>) x 100; liversomatic index (LSI) = liver mass/(fish mass - organ mass) x 100; and gonadosomatic index (GSI) = gonad mass/(fish mass - organ mass) x 100. Descriptive statistics were calculated using Microsoft Excel.

## 2.3 Results

### 2.3.1 Seasonal patterns in reproductive development and energy allocation

Trends in seasonal gonadal development (GSI) are presented in Figs. 2.2 (female) and 2.3 (male). Peak GSI for female bully averaged around 8% at each of the sampling sites throughout the study. Individual GSI ranged from a low of 0.22% during periods of reproductive quiescence up to 21% in gravid females prior to spawning. Male fish allocated significantly less energy to gonad development

with individual GSI ranging from 0.1% to a maximum of 4.9%. Although not quantified during this study, it was observed that male common bully appeared to allocate significant energy to the development of a reproductive accessory gland during the period of development that coincided with GSI peaks in females. While initial gonadal development commenced from May for all populations, significant differences in spawning time were observed between sample locations. A single peak in GSI exhibited at both downstream river sites suggests discrete winter spawning in these populations (peak GSI in July and September for DT and DR, respectively). In contrast, mean GSI in the two upstream river populations was elevated over a prolonged period, from late winter to mid-summer. Gravid females were observed during all sampling periods from July through to January in the UT, and from September to January in the UR.

Indicators of energy storage measured throughout the year included condition factor and liver somatic index. Seasonal trends were exhibited in both male and female fish (Figs. 2.4 to 2.7). Male and female fish from both downstream sites exhibited peaks in condition factor and liver size, at, or close to, the onset of spawning. A subsequent decrease in these indices was exhibited post-spawning. Upstream site trends were slightly more variable, possibly linked to intraspecific differences of reproductive development stages (as indicated by GSI) at those sites.

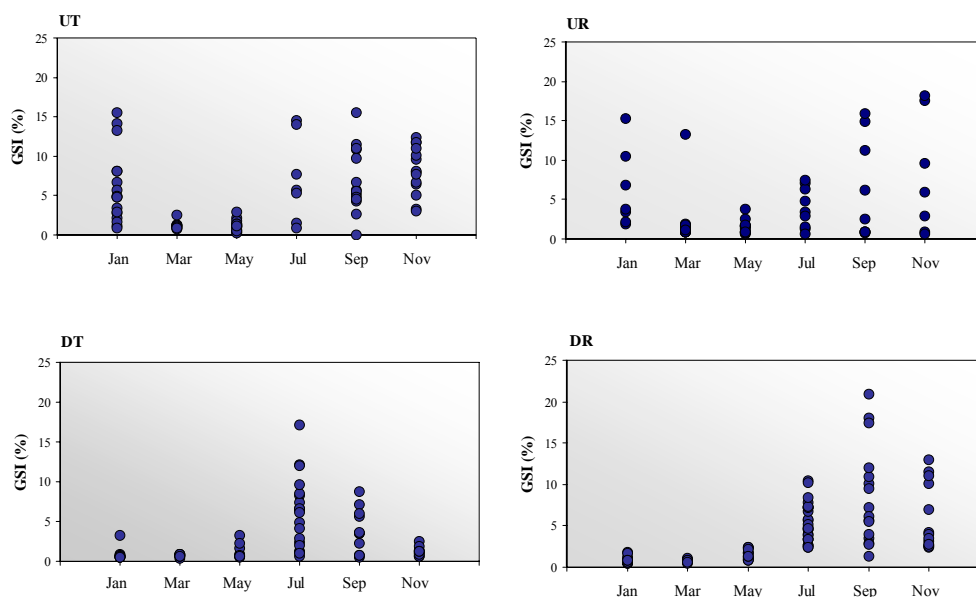

Figure 2.2. Annual trends in female common bully gonadosomatic index (GSI).

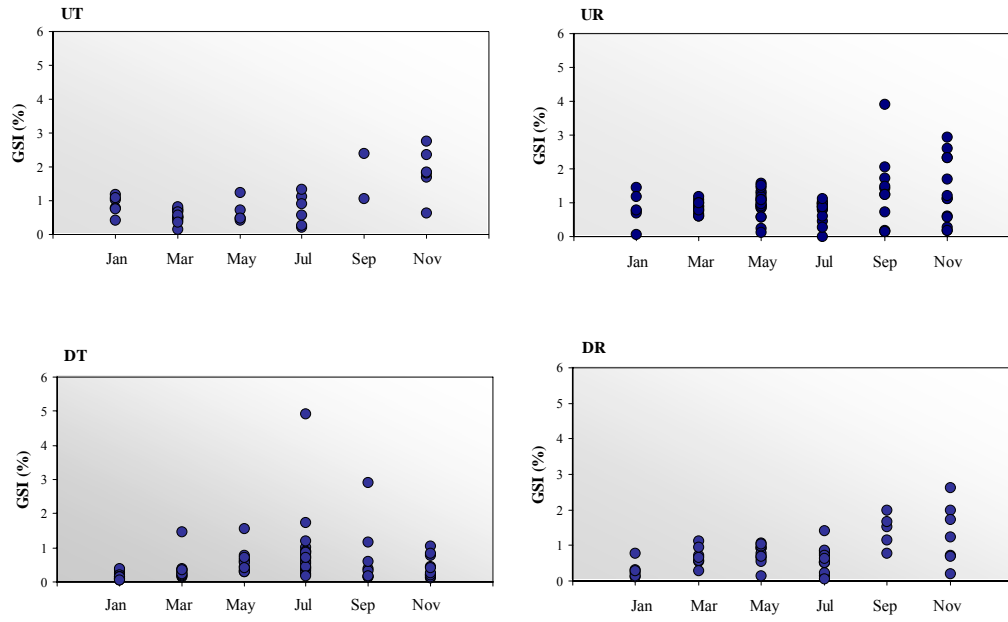

Figure 2.3. Annual trends in male common bully gonadosomatic index (GSI).

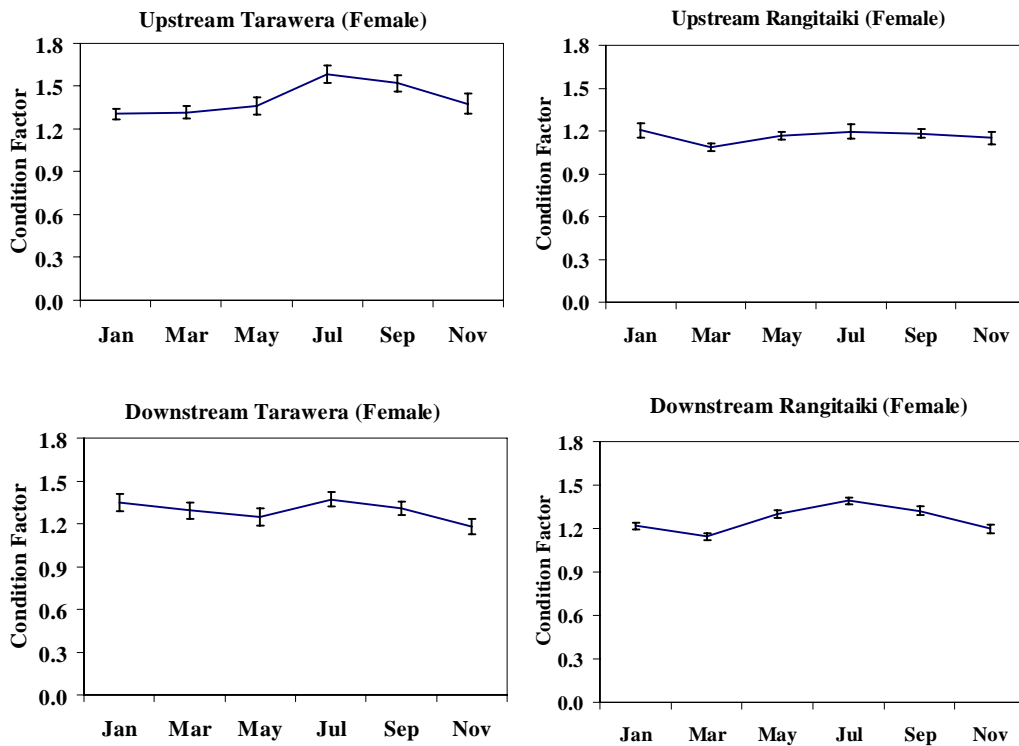

Figure 2.4. Mean ( $\pm$  SEM) female condition factor.

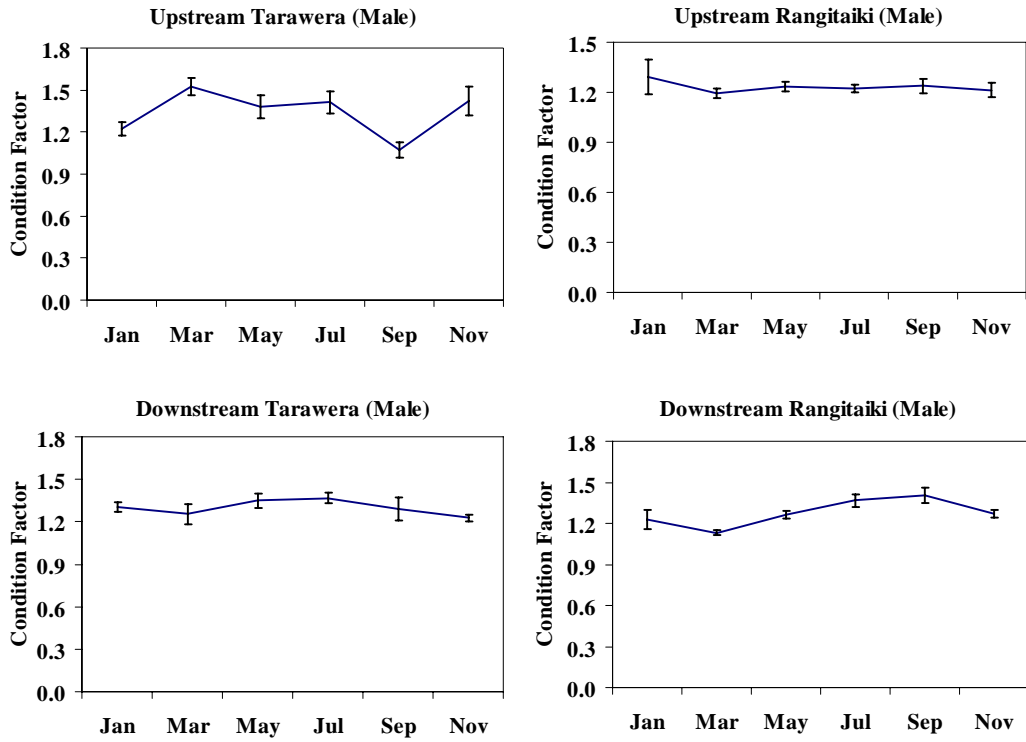

Figure 2.5. Mean ( $\pm$  SEM) male condition factor.

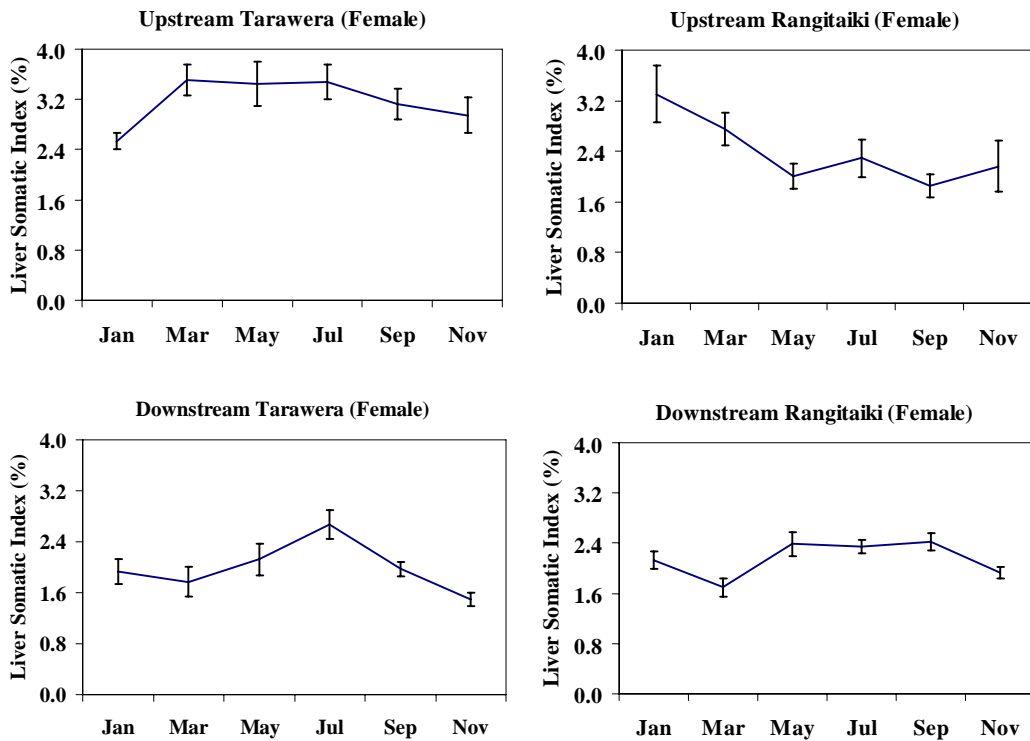

Figure 2.6. Mean ( $\pm$  SEM) female liver somatic index.

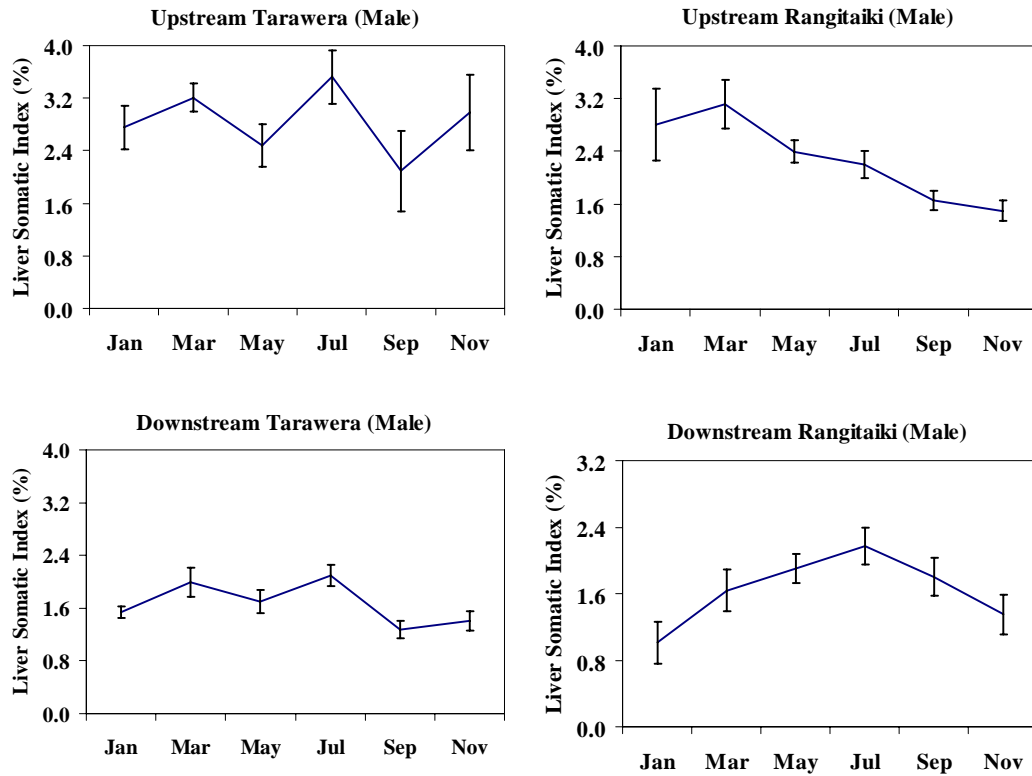

Figure 2.7. Mean ( $\pm$  SEM) male liver somatic index.

### 2.3.2 Stable isotopes

Significant site differences were observed in  $\delta^{13}\text{C}$  and  $\delta^{15}\text{N}$  isotopes (Fig. 2.8). Temporal variation was minimal. Within the Tarawera River, fish sampled from the downstream site showed a strong shift in  $\delta^{13}\text{C}$  with a reduction of approximately 5‰ compared to the upstream site. A slightly depleted  $\delta^{15}\text{N}$  signature was also observed. Rangitaiki River fish generally had a much higher  $\delta^{15}\text{N}$  signature compared to Tarawera River fish. A trend of decreasing  $\delta^{13}\text{C}$  and  $\delta^{15}\text{N}$  occurred downstream in both rivers.

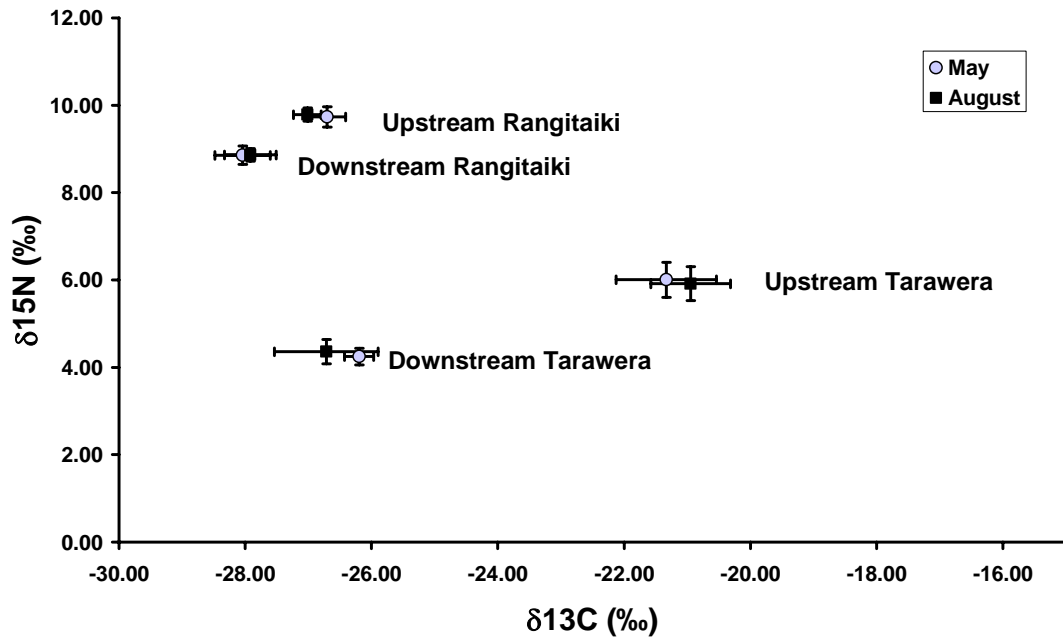

Figure 2.8. Mean ( $\pm$  95% confidence interval) stable isotope ratios of carbon and nitrogen in common bully (*G. cotidianus*) from each sample site during the May and August (2007) sampling period. NT = 145.

### 2.3.3 Vertebrae numbers

Vertebral counts varied between 28 and 29, with most fish having 29 vertebrae (Table 2.1). However, DR was the only site that had consistent vertebral counts of 29 per individual. The UT, UR and DT all exhibited fish with the lower vertebral count of 28 (19%, 8% and 13%, respectively).

### 2.3.4 Head canal morphotypes

Micrographs of common bully head pore structure-types are shown in Plate 2.5. High variation in oculoscapular canal morphotypes were observed between sampling sites (Table 2.2). Individuals with full canal formation (Type 1) were observed at all locations, with the highest numbers found at DR (100%) and the DT (93%). Many individuals in the UT and UR had under-developed oculoscapular canals (Type 2; 24% and 4%, type 4; 12% (UT)) or had lost all

canals (type 3; 25% and 65%, respectively). There was also a small number of DT fish with canals absent (type 3; 5%) or under-developed (type 4; 2%). The highest proportion of fish without canals was found in the UR (65%). The UT fish showed various degrees of deformity in lateral canals (Plate 2.5F), and asymmetrical pore patterns were also observed (Plate 2.5E). No differences in canal structure were observed between sexes.

Table 2.1. Descriptive analyses of otolith and vertebral counts for each sample site. UT = upstream Tarawera, DT = downstream Tarawera, UR = upstream Rangitaiki, DR = downstream Rangitaiki. NO = number of samples included in otolith analyses, %ND = proportion of non-diadromous fish, %D = proportion of diadromous fish, NV = number of samples included in vertebral analyses, %29 = number of fish with 29 vertebrae, %28 = number of fish with 28 vertebrae.

Site	Otoliths			Vertebrae Count		
	N <sub>O</sub>	% <sub>ND</sub>	% <sub>D</sub>	N <sub>V</sub>	% <sub>29</sub>	% <sub>28</sub>
UT	14	100%	0%	21	81%	19%
DT	14	29%	71%	24	87%	13%
UR	12	50%	50%	13	92%	8%
DR	15	0%	100%	35	100%	0%

Table 2.2. Meristic analyses of oculoscapular lateral line canals. Type 1, 2, 3 and 4 = proportion of respective morphotype in sample site. UT = Upstream Tarawera, DT = Downstream Tarawera, UR = Upstream Rangitaiki, DR = Downstream Rangitaiki. N = number of individual fish per sample site included in morphological analyses.

Site	N	Type 1	Type 2	Type 3	Type 4
UT	57	39%	24%	25%	12%
DT	60	93%	0%	5%	2%
UR	52	31%	4%	65%	0%
DR	58	100%	0%	0%	0%

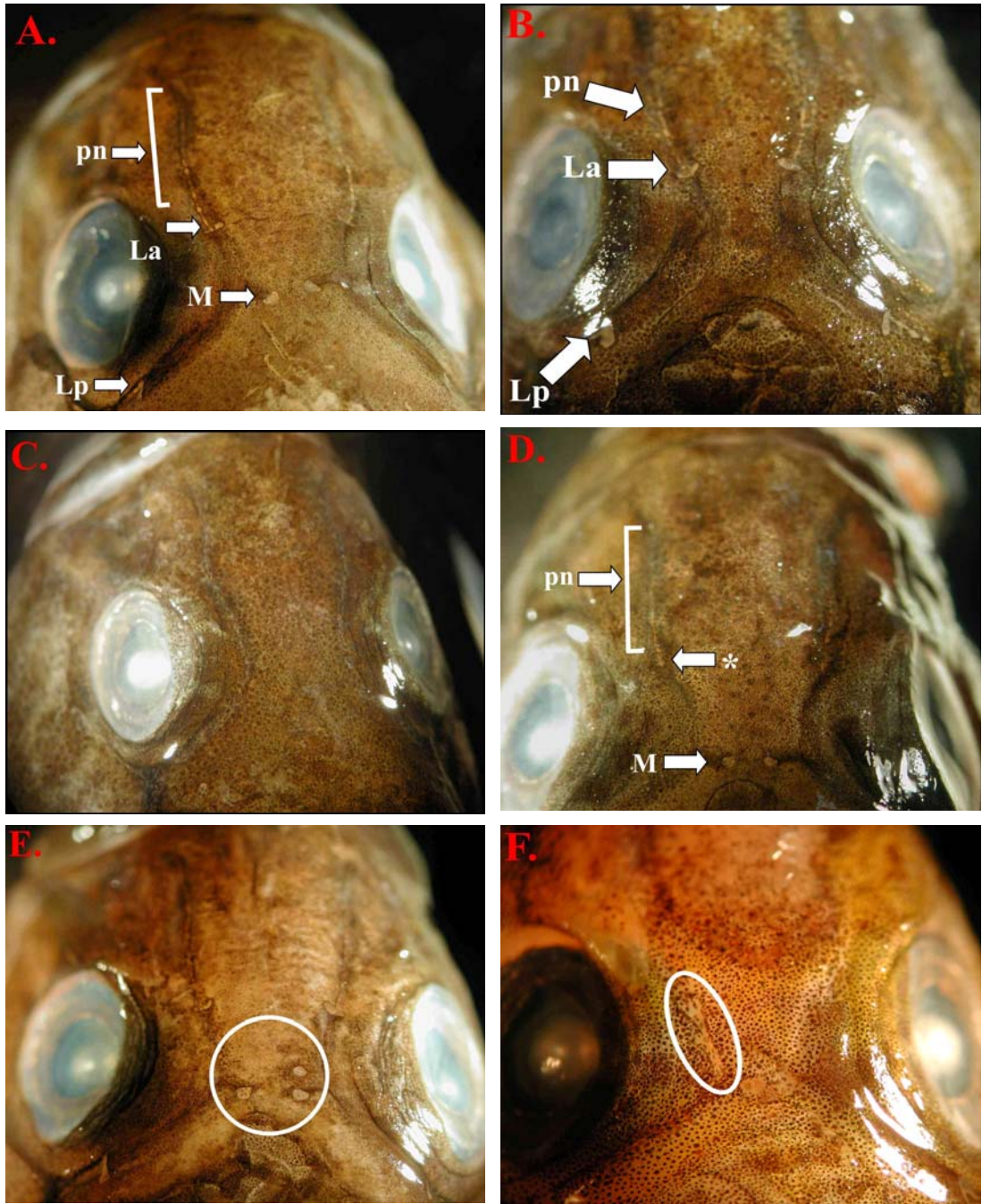

Plate 2.5. Cephalic oculoscapular canal structure of the common bully (*G. cotidianus*). Defined canal morphotypes are shown in A-D (type 1 to type 4, respectively). Median pores (M), lateral pores (La = lateral anterior, Lp = posterior pores), and primary neuromasts (pn). Asterisks in (D) points to reduced anterior lateral pores. Circled in E, and F are unsymmetrical pore structure and deformed 'split' canals, respectively.

### *2.3.5 Elemental water analysis and otolith microchemistry*

Elemental analysis of fish sampling site and coastal water samples have been summarised and are presented in Table 2.3. Analysis revealed a similar Ba/Ca ratio of approximately 6‰ in river water samples. The greatest concentrations of Sr and Ca were expectedly measured in seawater with a Sr/Ca ratio of approximately 29.6‰. Lower concentrations of Sr and Ca were measured in river water samples where Sr/Ca ratios were 14.6 and 7.9‰ in the Rangitaiki and Tarawera Rivers, respectively. Seasonal variations in water Sr, Ba and Ca concentrations were minimal. Compared to the Rangitaiki, the Tarawera River possessed greater concentrations of geothermally-derived elements (e.g. Li, B, As, Hg) and approximately 5- to 6-fold greater salinity. Considerable differences in upstream versus downstream concentrations of these elements was also observed in the Tarawera River indicating an input source(s) of these elements between the UT and DT sites, presumably from the geothermal bore field and pulp mill effluent-derived Na from the chemical pulping process. Greater concentrations of Cr and Fe at DT also support this hypothesis. Strong seasonal changes were observed in Mn in both rivers, with this element being elevated in summer and depleted in winter.

Table 2.3. Mean ( $\pm$  SEM) seasonal water elemental chemistry results for river sites (UT = upstream Tarawera, DT = downstream Tarawera, UR = upstream Rangitaiki, DR = downstream Rangitaiki) and coastal seawater samples. Salt water detection limits are high due to sample dilution required for ICPMS analysis. All units are in  $\mu\text{g/L}$ . n.d = below detection limit.

Isotope	ICPMS detection limits		Site				
	Freshwater	Salt water	UT ( <i>n</i> = 5)	DT ( <i>n</i> = 5)	UR ( <i>n</i> = 5)	DR ( <i>n</i> = 5)	Sea water ( <i>n</i> = 2)
Li 7	0.20	200	281 (7.62)	307 (8.17)	9.41 (0.31)	8.93 (0.49)	137 (4.42)
B 10	5.00	5000	313 (8.36)	694 (19.9)	73.9 (4.10)	69.5 (5.17)	2051 (10.4)
Na 23	20.0	20000	46970 (1430)	59764 (2022)	8412 (375)	7864 (532)	8985747 (509298)
Mg 24	20.0	20000	5822 (263)	5571 (216)	2079 (88.5)	1971 (134)	1256272 (88333)
P 31	20.0	20000	59.1 (10.6)	83.9 (8.11)	20.8 (4.82)	25.7 (4.04)	4236 (1093)
K 39	50.0	50000	5242 (213)	6287 (169)	2545 (86.9)	2392 (121)	332800 (24368)
Ca 43	50.0	50000	3826 (160)	4944 (205)	3144 (117)	3053 (151)	245896 (17670)
Cr 52	0.50	500	n.d	2.17 (0.56)	n.d	n.d	84.9 (5.92)
Fe 54	20.0	20000	51.0 (6.82)	109 (7.69)	35.2 (2.57)	137 (64.1)	2486 (167)
Mn 55	0.50	500	12.4 (6.77)	12.1 (7.86)	1.76 (0.74)	14.3 (6.68)	2.17 (1.83)
As 75	1.00	1000	21.9 (0.99)	31.3 (1.37)	0.56 (0.02)	0.59 (0.02)	31.1 (17.1)
Sr 88	0.50	500	32.2 (1.13)	36.7 (0.97)	45.8 (1.40)	44.5 (1.65)	7268 (583)
Ba 137	0.50	500	23.3 (1.47)	30.2 (0.86)	17.9 (0.81)	17.8 (0.72)	n.d
Hg 202	0.20	200	0.64 (0.25)	2.57 (0.39)	0.08 (0.06)	n.d	195 (18.0)

Individual core isotopic ratios of Sr/Ca and Ba/Ca are plotted in Fig. 2.9. for ease of comparison. In diadromous fish, the Sr/Ca ratios in the core of the otolith were higher (mean = 6.8‰, N = 31) than in non-diadromous individuals (mean = 3.5 ‰, N =24) (data not shown), and all exhibited a characteristic increase in Ba/Ca and decrease in Sr/Ca from the nucleus to the edge of the otolith. All UT (100%) specimens were clustered together and exhibited non-diadromous profiles indicative of a complete freshwater life-cycle with no larval marine influence. However, these fish did not exhibit high core Ba typical of freshwater resident fish. This observation is difficult to understand given that Ba/Ca ratios in all water samples were similar. Non-diadromous individuals were also present in the DT (29%) and the UR (50%) evident by high core Ba/Ca ratio. Interestingly, a proportion of fish of the UR showed both relatively high Sr/Ca (4-5‰) and Ba/Ca (0.1-0.3‰) in the core. However, these were presumed to be non-diadromous considering the high natural strontium in the Rangitaiki River water. The higher Sr/Ca ratio in the Rangitaiki River water samples was also reflected in higher average otolith Sr/Ca edge ratios in the Rangitaiki fish compared to Tarawera fish. The highest proportion of migratory amphidromous common bully was in the downstream Rangitaiki (100%), with all fish showing evidence of a marine larval stage. Similarly, in the DT, 71% of specimens were diadromous, while from the UR 50% were diadromous (Table 2.1).

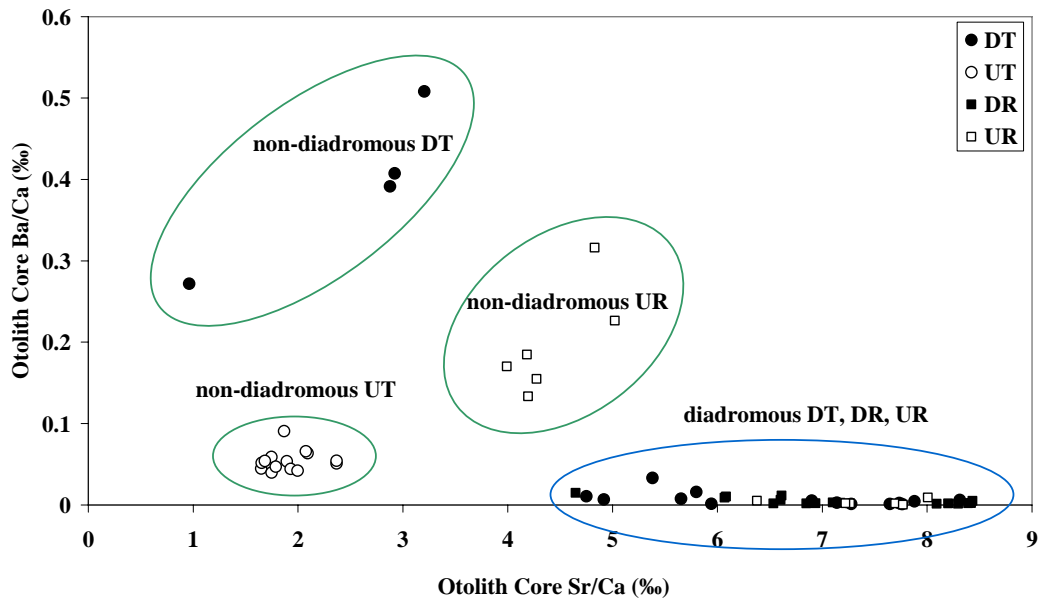

Figure 2.9. Discrimination of diadromous from non-diadromous common bully (*G. cotidianus*) by ratios of  $\text{Sr}^{88}/\text{Ca}^{43}$  and  $\text{Ba}^{137}/\text{Ca}^{43}$  in the otolith nucleus.

## 2.4 Discussion

This study confirms the status of common bully as being facultatively diadromous (McDowall, 1990; Closs et al., 2003), as demonstrated by the co-existence of amphidromous and non-amphidromous fish within two adjacent Bay of Plenty rivers with unimpeded access to the sea. Longitudinal upstream river trends were observed in migratory behaviour, reproductive timing and morphology.

Otolith microchemistry confirmed a lack of diadromous recruits in the UT, and predominance of amphidromous individuals in the DT, although some non-diadromous fish were also present at this site. These findings are in agreement with the findings of Michel et al. (2008). Common bully from the adjacent UR also exhibited a similar but less pronounced loss of diadromy with inland distance. All DR fish showed evidence of a marine larval stage consistent with amphidromy, whereas the UR population showed a mixture of migratory and non-migratory individuals. Long-term site residency of adult fish was confirmed by distinctive isotopic signatures of  $\delta^{13}\text{C}$  and  $\delta^{15}\text{N}$ , which were strongly influenced by ecosystem and catchment characteristics. Fish from DT reflected the

assimilation of terrestrial pulp and paper-sourced carbon and nitrogen, a common observation in systems receiving pulp and paper mill effluents (Wayland & Hobson 2001; West 2006; Landman et al. in press). The upstream Tarawera fish exhibited high  $\delta^{13}\text{C}$  values, reflective of old Lake Tarawera water dominating in this section of the river. This value decreased downstream as the older lake water became increasingly diluted by tributary input and equilibrated with atmospheric  $\text{CO}_2$ , as demonstrated in other New Zealand river systems (Fitzgerald, 1996). Enrichment of  $^{15}\text{N}$  in Rangitaiki fish flesh was likely a factor of high levels of agricultural input (i.e. animal wastes, fertilizers) within the upper and lower catchment of this river.

As expected, amphidromy dominated in the two downstream river sections which were closest to the sea and a loss of diadromy was generally exhibited with inland distance. The loss of the seaward migratory phase in some of these populations may be explained by several alternative hypotheses. Given that diadromy in this fish species is facultative, Closs et al. (2003) suggested that if there is appropriate larval and juvenile rearing habitat present within a freshwater system, riverine stocks of common bully might choose to abandon their marine migratory phase. This could be a factor in the DT, where extensive marginal weed-stands and high productivity from the pulp mill inputs could provide suitable slow flowing and energy rich microhabitats. Voluntary loss of migration may also explain the UR population. Alternatively, the congruence of mixed migratory types in this section of the river, located close to the base of the Matahina Dam, may further be explained by non-diadromous, larval washouts from above the dam.

Unlike the Tarawera River which is lake-derived, the Rangitaiki is wholly catchment-fed, and further upstream of the UR site, the river has been hydrologically modified. This includes the addition of two hydro-electricity dam structures and associated reservoirs. The New Zealand Freshwater Fish Database<sup>2</sup> shows common bully above the Matahina dam right up into the headwaters of the catchment of the Rangitaiki River (Fig. 2.10). This suggests that prior to hydrological modification of the river system, common bully penetrated considerable inland distances to colonise those areas. There is no evidence or

---

<sup>2</sup> <http://www.niwa.cri.nz/services/free/nzffd>

literature to suggest the common bully above the dam were introduced, as is the case in Lake Tarawera (Burstall, 1980). The Matahina Dam, which has now been in operation for approximately 50 years represents a significant barrier to upstream migration and has resulted in landlocking of the upstream populations. Similar to the Tarawera system, there is still the possibility of downstream transport of fish to the lower section of the river through larval washout from the reservoir.

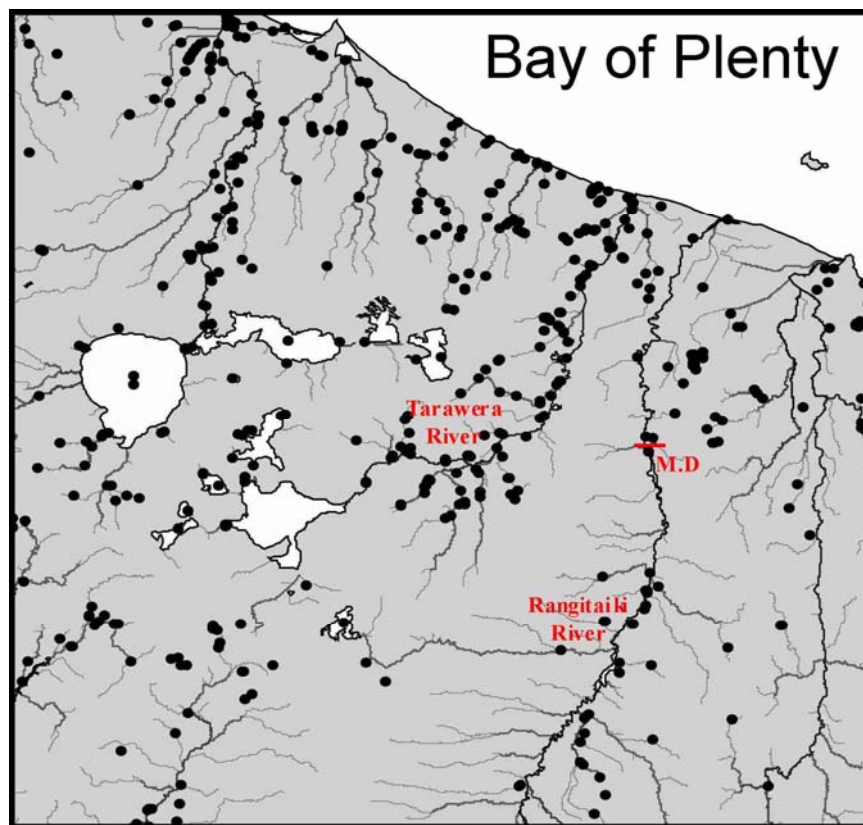

Figure 2.10. Reported distributions of common bully (*G. cotidianus*) in the Tarawera and Rangitaiki River systems by the New Zealand Freshwater Fish Database (NZFFD, NIWA, NZ). MD = Matahina dam.

The absence of diadromous recruitment to the UT site is difficult to explain. It is unlikely this finding is solely due to distance inland, given that the UR site is roughly the same distance inland yet exhibited both migratory types. Michel et al. (2008) suggest that the lack of seaward migration in the UT fish may be explained by a hereditary predisposition in this population. While this is plausible, it does not explain the lack of movement of migratory fish from

downstream to the upper reaches. The Tarawera River receives various natural and anthropogenic inputs between the upstream and downstream sites that may act to limit fish migration. Water chemistry clearly demonstrated an increase in geothermally-derived elements such as Li, B, As and Hg. Some metals are known to be potent fish toxicants and may result in behavioural avoidance even at sub-lethal concentrations (Hartwell et al., 1987; Woodward et al., 1997; Hansen et al., 1999). Avoidance of the pulp and paper mill effluent has also been suggested (van den Heuvel et al., 2007; Michel et al., 2008). Directed research is essential to further our understanding of the possible mechanisms resulting in reproductive isolation and migratory impediment in the Tarawera River.

Substantial morphological variation of the oculoscapular canal system was observed in fish between the paired river sites. In particular, fish with full canal development dominated the DR and DT sites, supporting the predominance of amphidromous life-strategies in these populations. In contrast, the UR and UT populations exhibited a mixture of full or partial loss of canal structures Michel et al. (2008) observed no fish with full canal development in the non-diadromous UT population. The current study contradicts this finding with nearly 40% the upper river fish possessing fully developed canal structures. Increased sample size in the current study may explain some of the variability in these results. However, the same general trend applied where reduced canal formation was associated with inland distance and a loss of diadromy. This pattern of canal reduction parallels canal reduction exhibited in many non-diadromous lake populations of common bully (McDowall, 1990), including those from Lake Tarawera (Michel et al., 2008). Furthermore, it resembles the absence of oculoscapular canals in other obligatory fluvial NZ *Gobiomorphus* species (McDowall 1990), including the recently evolved ecophenotype of the common bully, the Tarndale bully (McDowall, 1994; Smith et al., 2003; McDowall & Stevens, 2007).

Canal formation in the gobiids can be both phenotypically plastic as result of environmental flow rates (Coombs et al., 1992), or a hereditary response (Ahnelt et al., 2004). In the case of the UT and UR common bully populations, it may be interplay of both. Canal formation in gobiids is believed to occur in the late larval to early juvenile stages of ontogeny (Fuiman et al., 2004; Modgans, 2005), corresponding to the time of return migration of amphidromous common bully (i.e. 2-3 months). Thus, during this developmental stage, amphidromous

bullies are exposed to flowing water conditions and therefore may develop full oculoscapular canals. In contrast, reduced formation of canals in freshwater resident common bully may be attributed to the occupation of slow-flowing benthic microhabitats (i.e. marginal weed-stands) in the river system during this same period of development (Modgans, 2005). Michel et al. (2008) suggested that concordance of canal morphotypes with the genetic similarity observed between the UT and Lake Tarawera bullies might indicate that this morphological variation is partly governed by genetic components rather than a completely plastic response to the environment. However, in making these assumptions it must be noted that the genetic marker they used (AFLPs) are anonymous and most likely do not represent the certain genomic region regulating canal morphotype or migratory behaviour in these fish. It could well-be that the genetic structure observed might merely reflect a biogeographic structure that agrees with the distribution of canal morphotypes as well as migratory types. Unfortunately, genetic analysis has not been conducted on UR fish, and therefore we can not make an assumption of the inherited characteristics for this population. However, if these non-diadromous individuals were derived from larval washout from above the dam, there is potential for a similar scenario to occur in this population.

Vertebral counts for common bully in both rivers were within the range (i.e. 28-29 vertebrae) previously reported by McDowall & Stevens (2007) for this species. However, in that same study, of the 50 fish sampled, 98% of those had 29 vertebrae and only 2% had 28. The current study revealed greater variation with up to 18% of some populations exhibiting 28 vertebrae. The only site that showed consistent individual vertebral counts was the fully diadromous DR population. Whether or not the lower vertebral counts in the populations with non-diadromous bullies is a factor of a loss of diadromy as in other fish species such as inanga (*Galaxias maculatus*; McDowall, 2003) and smelt (Ward et al., 2005), or due to natural variation cannot be confirmed from this data.

Bimonthly tracking of gonadal development revealed interesting upstream and downstream trends that were evident in both rivers. Initial work in the Tarawera River has generally categorised upstream common bully populations as summer spawners and the downstream as winter spawners (van den Heuvel et al., 2007; Michel et al., 2008). Although generally true, our study demonstrated that the relationship is somewhat more complex. A single peak in GSI exhibited in the

two predominantly diadromous downstream populations (July and September for the DT and DR, respectively) was followed by a sharp decline, indicative that they were annual spawners with a highly defined and relatively short breeding season. In contrast, the two predominantly non-diadromous upstream common bully populations appeared to have a prolonged spawning season, with mature females (i.e. high GSI above 10%) present from the end of winter to the end of summer, suggesting sympatric presence of both winter and summer spawning types. The spawning pattern observed in the latter coincides with reported protracted summer spawning of other non-diadromous landlocked common bully populations (Stephens, 1982). Shifts in reproductive timing have also been reported in other fish species such as the non-diadromous, landlocked common smelt which usually spawn in spring-summer, whereas their diadromous conspecifics spawn during autumn-winter (Ward et al., 2005). The reason for these shifts in timing are unclear, however, high correlation between spawning season and migratory behaviour suggests that shifts in timing have a selective advantage and/or are a necessary adaptation to differences in seasonal food availability and predation on larvae between fluvial systems and the marine environment (Ovenden & White, 1990; Michele et al., 2008). This would enable the better capitalisation of conditions for growth and survival (Humphries, 1989).

Annual trends in energy storage and allocation (condition factor and liver somatic index) associated well with gonadal development. Condition factor is known to vary seasonally (Griffiths and Kirkwood, 1995; Galloway & Munkittrick, 2006), possibly as a factor of food availability and gonadal status (Chellappa et al., 1995). Because of the energy storage and metabolic functions of the liver, nutritional quality and regimes may contribute to changes in liver size (Foster et al., 1993). Alterations in female liver size with reproductive development has been linked to the role of the liver during vitellogenesis (Scott & Pankhurst, 1992).

Collectively, the results of this study and those of van den Heuvel et al. (2007) and Michel et al. (2008) indicate the presence of distinct ecomorphotypes of amphidromous and non-amphidromous populations of common bully coexisting within two river systems with unimpeded access to the sea. Although a loss of diadromy and the associated morphological variation appears to be at least partially a factor of inland distance, the complete lack of diadromous recruits to

the upstream Tarawera suggests that some other influence in the river may impede the upstream movements of fish in this river. Future work should therefore investigate the pulp and paper mill effluent discharges, and/or other anthropogenic inputs as potential barriers to common bully migration. Additionally, genetic studies should be undertaken in order to elucidate divergence mechanisms between alternative life history strategies exhibited in these populations. This should encompass fish from above the Matahina Dam to infer genetic and morphological relationships in the Rangitaiki common bully populations. A comparative genetic study should also be conducted between Waikato River (Mercer) and Lake Tarawera/upstream Tarawera common bully populations to investigate the assumption of genetic linkage of these fish made by Michel et al. (2008).

## **Chapter Three**

**Avoidance response of common bully exposed to pulp and paper effluent**

## 3.2 Introduction

Preliminary investigations of the facultatively diadromous common bully (*Gobiomorphus cotidianus*) within the Tarawera River observed marked differences in genetic and morphological characteristics between upstream and downstream subpopulations (van den Heuvel et al., 2007; Michel et al., 2008; Chapter 2). Despite relatively short distances between populations (~17 km), analysis of otolith microchemistry revealed that the downstream population included a mixture of diadromous and non-diadromous fish, whereas the upstream population was solely composed of non-diadromous fish indicating a lack of marine recruitment. In addition, differences in reproductive timing suggest a possible mechanism of isolation between these populations (Michel et al., 2008), although probable spawning overlaps likely exist (Chapter 2). Chapter 2 investigated the relationship between inland distance and life-history through analysis of common bully populations in the Tarawera and adjacent Rangitaiki River. This study concluded that distance was unlikely to be the sole factor influencing inland penetration of marine migrants given that diadromous fish were found in the upstream Rangitaiki River, roughly corresponding to the inland distance of the upstream Tarawera River population (~40 km). A logical hypothesis that arose from these studies was the possibility that a significant pulp and paper mill wastewater discharge into the Tarawera River (130,000 m<sup>3</sup>/d) may be acting as a chemical barrier in the river, influencing the distribution and migratory patterns of common bully.

Although physical barriers (e.g. waterfalls) represent obvious barriers to migration, anthropogenic discharges are capable of influencing fish behaviour, potentially acting as chemical barriers through avoidance responses (Sprague, 1968; Kroon, 2005). Behavioural ecotoxicology combines the three disciplines of ethology, ecology and toxicology to determine the effects of environmental pollutants on the behaviour of an organism (Dell'Omo, 2002). The field of behavioural toxicology has grown over the past 20 years, with greater interest being partially attributed to an increase in the number of species used, the endpoints measured and the methods available to collect and interpret data. In a comprehensive review on aquatic behavioural toxicology, Rand (1985) stated that in order to be most useful in aquatic toxicology, behavioural endpoints should be:

well-defined and practical to measure; well-understood relative to environmental factors that cause variation in the response; sensitive to a range of contaminants and adaptable to different species; and ecologically relevant.

Studies of preference and avoidance are amongst the most common methods in behavioural fish toxicology (see reviews of Beitinger & Freeman, 1983; Giattina & Garton, 1983, and Svecevieius, 2007). Numerous laboratory and field studies have shown that fish may actively avoid a variety of environmental stressors such as thermal effluents and gas supersaturation (Gray, 1983), pesticides (Hogue, 1999; Saglio et al., 2001), metals (Atland, 1998; Scherer & McNicol, 1998), chlorine (Cherry et al., 1979), sedimentation (Boubée et al., 1997), and low pH (Kroon, 2005). Avoidance may have significant adaptive advantages in the short-term by minimising exposure and injury caused in the presence of toxicants (Little et al., 1993; Delonay et al., 1996). Fish may also show avoidance to substances at concentrations below those that are acutely toxic (Little et al., 1985). In the absence of acute or even sub-chronic effects, stressor avoidance may significantly affect populations by causing fragmentation, inducing emigration, or influencing juvenile recruitment thereby disrupting demography and community dynamics over time (Bridges, 1997).

The structure of New Zealand riverine fish communities often includes a high proportion of native migratory taxa and therefore understanding the factors that limit fish distribution is fundamental to their conservation (Adams et al., 2000, 2002; Dunham et al., 2002). The objective of the present study was to test the hypothesis that the presence of pulp and paper mill effluent may be acting as a chemical barrier to fish movements in the Tarawera River. To test this hypothesis in the laboratory, a choice chamber apparatus was employed to expose common bully to a simultaneous choice of effluent and river water.

## **3.2 Materials and methods**

### *3.2.1 Animals*

Common bully (*Gobiomorphus cotidianus*; 50-65 mm T.L.) were collected from Lake Tarawera (Bay of Plenty, North Island) using two lines of 10 minnow

traps set at 1-5 m depth overnight during December 2007. Upon retrieval, fish were immediately transferred to the laboratory in 20 L plastic pails within one hour of capture. Fish were held in flow-through aquaria supplied with dechlorinated, aerated Rotorua City tap water at  $15 \pm 0.5^\circ\text{C}$ . Animals were maintained on a natural photoperiod, fed daily with frozen blood worms (Aqua One KS) and held for less than 1 week prior to experimentation to minimise acclimation to artificial conditions.

### *3.2.2 Water and effluent chemistry*

Effluent used in this experiment was final Tasman Mill (Chapter 1) effluent obtained at the outfall of the secondary treatment system (Plates 3.1 and 3.2). Despite considerable day-to-day fluctuations in organic effluent chemistry (van den Heuvel et al., 2004), the effluent collected was considered to be representative of effluent discharged into the Tarawera River during normal mill operation. Reference upstream Tarawera River water for control and dilution purpose was obtained at the Kawerau Township upstream of the mill inputs. Water and effluent samples were collected using a generator-powered submersible pump and stored in two separate 1000 L containers. The water and effluent samples were transported to Scion (Rotorua, NZ) and used within a week of collection. Effluent was stored on site in a refrigerated shipping container at  $4^\circ\text{C}$  and brought up to ambient temperature ( $16\text{-}18.5^\circ\text{C}$ ) prior to experimentation.

Water quality parameters measured included conductivity, pH and organic extractives. Subsamples (1 L) of water and effluent were taken upon delivery to the laboratory and stored frozen at  $-20^\circ\text{C}$  pending analysis of organic extractives at Scion. Effluent samples were later thawed and 125 mL of sample was adjusted to pH 9.0 with NaOH. Surrogate standards (2,4,6-tribromoanisole, 2,4,6-tribromophenol, D10-anthracene, D31-palmitic acid, 8(14)-abietenic acid and dihydrocholesterol) were introduced immediately prior to extraction. Samples were continuously extracted with dichloromethane using glass liquid-liquid extractors. Extracts were passed through sodium sulphate and concentrated with nitrogen using a Zymark Turbovap. The final extract was silylated with bis(trimethylsilyl)-trifluoroacetamide plus 1% trichloromethylsilane and analyzed by gas chromatography with mass selective detection (GC-MSD). All analyte

concentrations were corrected for extraction blanks and adjusted for the recovery of the appropriate surrogate standard.



Plate 3.1. Final treatment pond at the Tasman site.

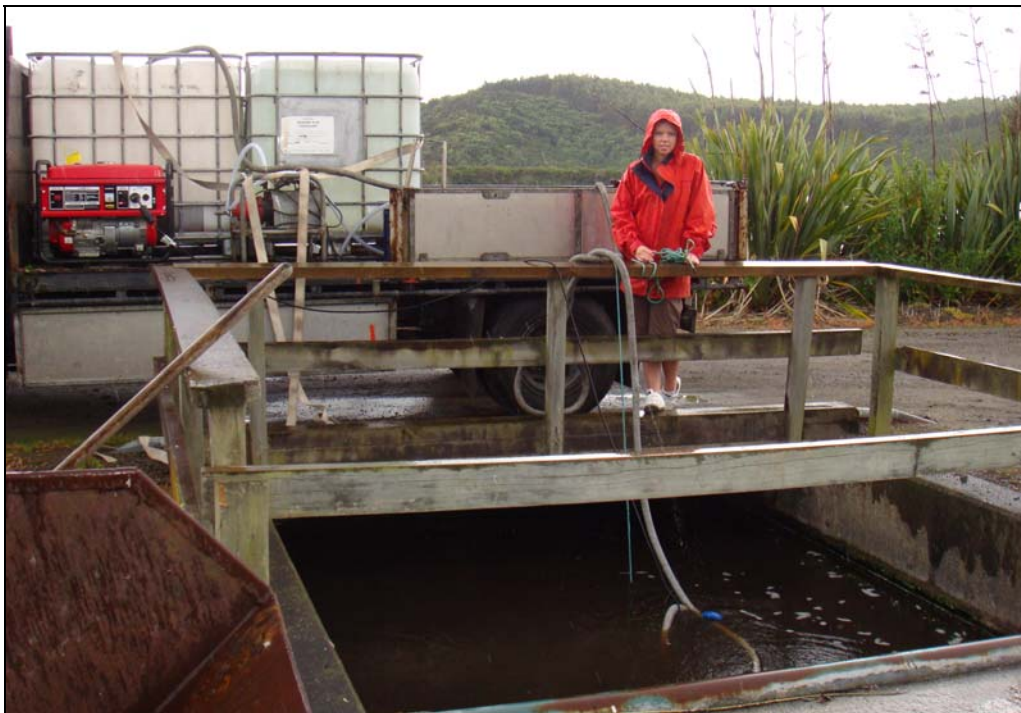

Plate 3.2. Effluent collection from the outfall of the final treatment system, Tasman site.

### *3.2.3 Preference experimentation*

#### *3.2.3.1 Experimental apparatus*

The experimental preference system and protocol was modelled from Baker and Montgomery (2001) and consisted of a main chamber which gave fish access to two choice chambers (Fig. 3.1). The entrance to each choice chamber was created using a funnel (OD 100 mm, ID 20 mm) which allowed easy access of the fish into the choice chamber, but prevented return of fish to the main chamber. The effluent and control water used within the experimental tank were held in two 150 L plastic drums individually fed into the choice chambers using silicon Masterflex tubing (OD 10 mm, ID 6.4 mm). Flow rate was kept constant during the experiments at 23 L/hr using electronically controlled, multi-channelled peristaltic pumps (Masterflex, Cole-Parmer Instrument Company). Rubber bungs inserted into the funnels allowed the choice chambers to be filled with the appropriate test waters. Each choice chamber held a volume of 4 L. The main chamber held 18 L of water. When the bungs were released water flowed from the choice chambers into the main chamber and emptied to waste at the rear of the tank. A ramp located at the downstream end of the main chamber helped reduce back flow vortices and a mesh screen situated above the ramp prevented fish escaping through the outflow. All trials were conducted during daylight hours in a darkened laboratory with an overhead 40 W light source placed 60 cm above the centre of the tank. Disturbance was minimised by staying out of sight.

#### *3.2.3.2 Experimental protocol*

At the beginning of each trial, rubber bungs were inserted into the entrance of the choice chambers. One choice chamber was filled with control water and the other with effluent. The main chamber was also filled with control water, as this was representative of the control Tarawera River conditions. An individual fish was introduced into the main chamber and allowed to acclimate to experimental conditions for 15 min. At the end of the acclimation period, the peristaltic pumps were switched on and the rubber bungs were released to initiate current flow and the fish was left for a period of 15 min. After this time the bungs were reinserted

and the position of the fish (control chamber, effluent chamber or main chamber) was recorded. Used fish were placed in a separate recovery tank and not reused in this experiment. Following each trial the choice chamber was emptied and cleaned with dechlorinated tap water before the next trial.

A geometric effluent dilution series (100, 50, 25, 12.5 and 0% v/v) was used to determine the behavioural preference/avoidance of exposed fish. For each concentration 20 trials were conducted with a different set of 20 individual fish ( $n = 100$ ). The effluent chamber was alternated between each treatment. The 0% effluent concentration acted as a control experiment to observe if common bully showed left/right bias behaviour to the choice chambers.

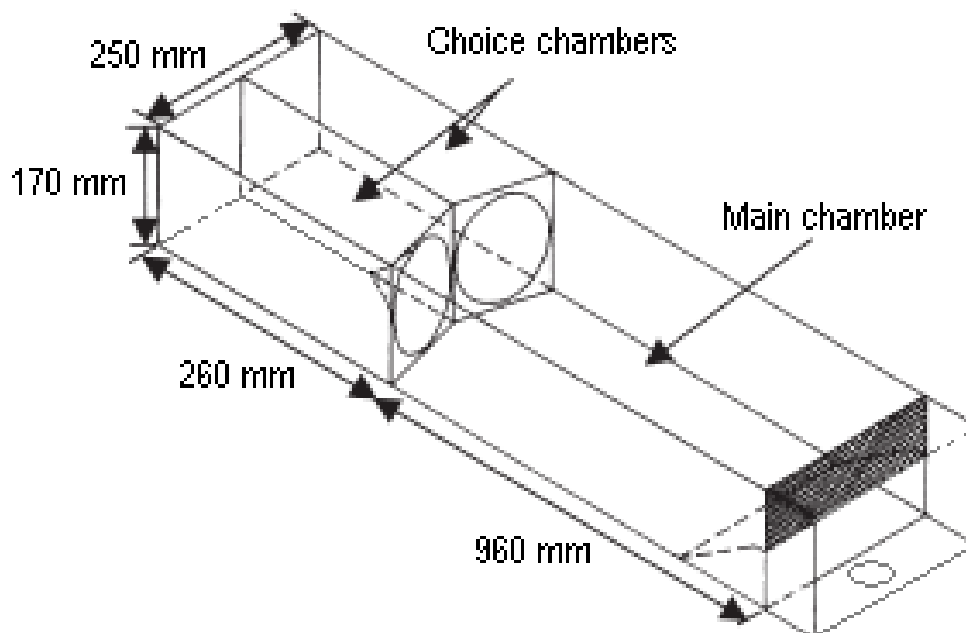

Figure 3.1. Schematic of experimental choice chamber apparatus.

### 3.2.4 Statistics

Preference or avoidance of particular chambers was tested for by comparing observed frequencies to expected frequencies using Chi-square. Expected frequencies were those observed in the control condition (0% effluent). The critical level of statistical significance for all tests was  $\alpha = 0.05$ .

### 3.2.5 Ethics Statement

This experiment was approved by the University of Waikato (Protocol 673) and Scion (Protocol 2007-002) Animal Ethics Committees.

## 3.3 Results

### 3.3.1 Water and effluent chemistry

Physicochemical characteristics of the control and effluent mixtures are summarised in Table 3.1. The pH and conductivity of the control river water were relatively consistent between each test, averaging  $7.85 \pm 0.08$  and  $322 \pm 4.27$  (mean  $\pm$  sem)  $\mu\text{S}/\text{cm}$ , respectively. Effluent conductivity ( $1082 \mu\text{S}/\text{cm}$ ) was high compared to river water and declined linearly with dilution. Effluent pH was lower than river water (pH 7.31) and effluent dilutions ranged from 7.45 to 7.52. Water temperature was kept constant throughout the experiment at  $18^\circ\text{C} \pm 0.5^\circ\text{C}$ .

Total wood extractives based on single analyses of effluent and river water were 1884 and  $12.7 \mu\text{g}/\text{L}$ , respectively (Table 3.2). Effluent chemistry was dominated by the untransformed abietic, dehydroabietic and pimaric resin acids. Sterols were dominated by cholesterol and the plant-derived phytosterols, sitosterol and sitostanol. Some fatty acids and low concentrations of phenolic compounds were also detected in the effluent. The presence of low resin acid concentrations in the control river water is expected as the upper Tarawera River catchment is dominated by exotic *Pinus radiata* plantations.

### 3.3.2 Preference experiment

The results of the preference experiment are presented in Figure 3.2. When common bully were exposed to a simultaneous choice of 100% effluent and river water, 16 of 20 fish made a choice, and of those fish, 100% avoided the effluent and moved into the control chamber (Fig. 3.2A). Similarly, high avoidance was observed at 50% effluent concentration where 67% of fish that made a choice (15 of 20) avoided the effluent (Fig. 3.2B). In contrast, during 25 and 12.5% effluent exposures, there were no significant difference between the numbers of fish

moving into either choice chamber (Figs. 3.2C and D, respectively), and thus no avoidance response was inferred. During control exposures, significant left vs. right bias were not observed (Fig. 3.2E). Only two of 20 (10%) failed to make a choice within the given time period and remained in the main chamber.

Table 3.1. Comparison of the physicochemical characteristics, including pH and conductivity ( $\mu\text{S}/\text{cm}$ ), of the control water (mean, ( $\pm$  St.Dev, n)) and TMP/BKME effluent treatments.

Sample batch	pH	Conductivity ( $\mu\text{S}/\text{cm}$ )
Control	7.85 (0.08, 5)	322 (4.27, 5)
100% Effluent	7.31	1082
50% Effluent	7.45	746
25% Effluent	7.50	533
12.5% Effluent	7.52	381

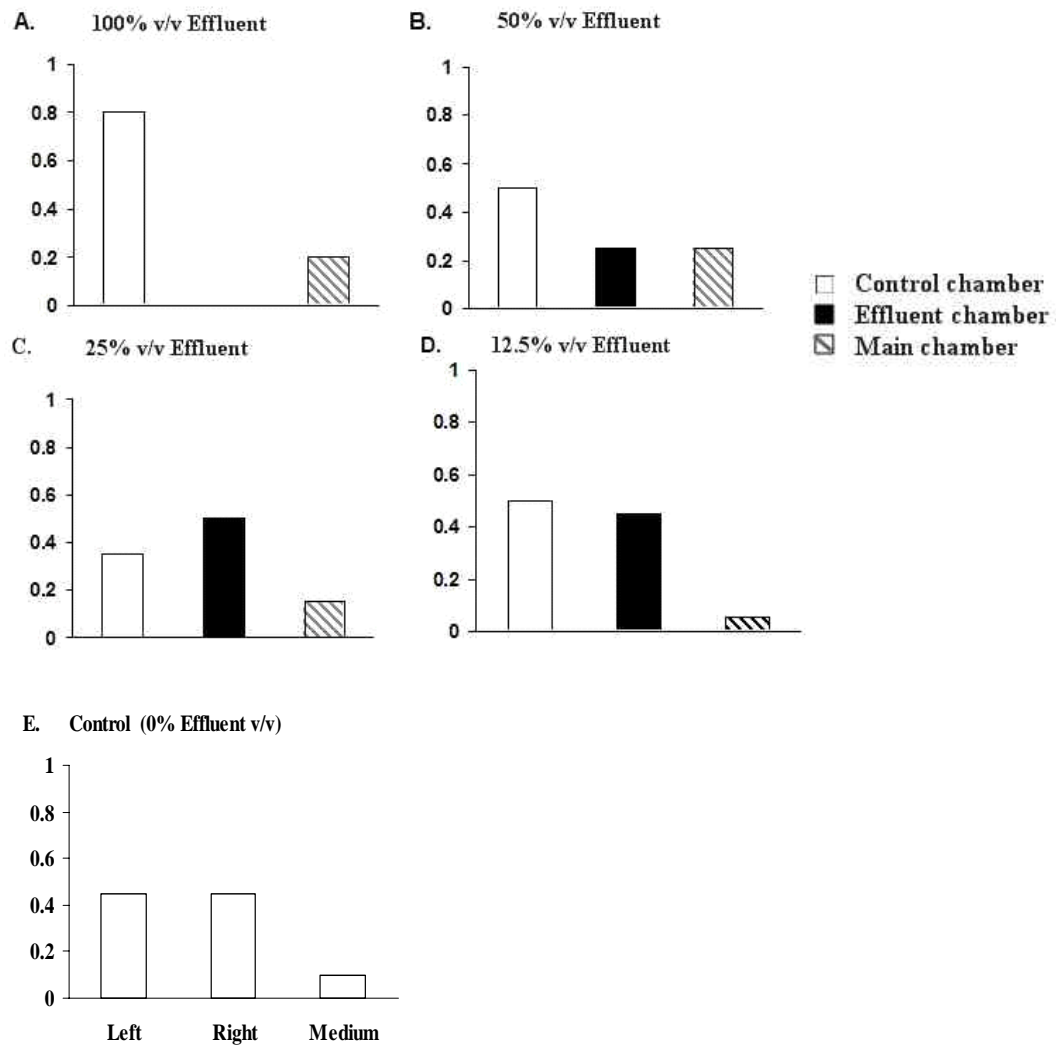

Figure 3.2. Proportion of common bullies (*G. cotidianus*) present in each chamber when subjected to varying effluent concentrations (A, B, C, D). Significant avoidance was exhibited at 100 and 50% effluent v/v ( $p = 0.00027$ , and  $p = 0.041$ , respectively). For the control (E) experiment, only reference river water was used, and the proportion of fish that moved to each choice chamber (left, right) or remained in the main chamber, was recorded.  $N = 20$  fish per treatment.

Table 3.2. Organic extractive concentrations ( $\mu\text{g/L}$ ) in Tarawera River water and in undiluted whole Tasman Mill effluent.

<b>Compound</b>	<b>Control water</b>	<b>Effluent</b>
Vanillin	n.d.	0.33
Vanillic acid	n.d.	0.20
Acetosyringone	n.d.	0.03
Syringylaldehyde	n.d.	0.15
<b>Total Phenolics</b>	<b>n.d.</b>	<b>0.71</b>
Dodecanoic acid (F12:0)	0.30	n.d.
Palmitic acid (F16:0)	5.74	12.5
Oleic acid (F18:1)	n.d.	13.2
Elaidic acid (F18:1)	n.d.	2.07
Stearic acid (F18:0)	1.25	8.52
<b>Total Fatty Acids</b>	<b>7.29</b>	<b>36.4</b>
<b>Total Resin Acid Neutrals</b>	<b>n.d.</b>	<b>n.d.</b>
Pimaric acid	n.d.	216
Sandaracopimaric acid	n.d.	22.8
Isopimaric acid	n.d.	124
Palustric acid	n.d.	0.23
Dehydroabietic acid	0.77	218
Abietic acid	4.65	794
Pimarenic acid	n.d.	6.59
Sandaracopimarenic acid	n.d.	10.4
13-Abietenic acid	n.d.	75.2
Pimaranic acid	n.d.	4.37
Isopimaranic acid	n.d.	1.48
Abietanic acid	n.d.	12.9
Seco-1-dehydroabietic acid	n.d.	103
Seco-2-dehydroabietic acid	n.d.	51.3
12-Chlorodehydroabietic acid	n.d.	2.97
14-Chlorodehydroabietic acid	n.d.	18.9
<b>Total Resin Acids</b>	<b>5.43</b>	<b>1662</b>
Cholesterol	n.d.	47.9
Campesterol	n.d.	0.26
Stigmasterol	n.d.	25.0
Sitosterol	n.d.	74.7
Sitostanol	n.d.	37.8
<b>Total Phytosterols</b>	<b>n.d.</b>	<b>185.6</b>
<b>Total Extractives</b>	<b>12.7</b>	<b>1884</b>

Note. n.d, not detected, method detection limits is  $0.01\mu\text{g/L}$ .

### 3.4 Discussion

Previous studies have shown that common bully are able to detect and avoid metal contaminants such as copper (Richardson et al., 2001) demonstrating usefulness of this species in behavioural toxicology as a monitoring species. In the current study, effluent-naive common bully were clearly able to discriminate between a pulp and paper mill effluent and river water. Fish were observed to avoid effluent concentrations of 50 and 100% v/v, showing a strong preference for control river water. In contrast, no clear preference for river water or avoidance of effluent was observed during 12.5 and 25% v/v effluent exposures. Although avoidance of effluent occurred at environmentally unrealistic concentrations (i.e. >15% dilution), this study shows some potential for this effluent to act as a chemical barrier to migration in the Tarawera River.

Previous studies have implicated avoidance of contaminated flows in altered or limited fish distributions and migratory habits. Sprague et al. (1965) and Saunders & Sprague (1967) reported reduced upstream migration of returning Atlantic salmon (*Salmo salar*) in a stream contaminated with copper and zinc from mining activity. Hartwell et al. (1987) also observed avoidance of fathead minnows (*Pimephales promelas*) to a metal mixture (Cu, Cr, Ar, Se) in both the laboratory and in the wild.

Responses in the ability of fish to avoid sub-lethal concentrations of bleached kraft mill effluent (BKME) in the laboratory have previously been reported in many earlier studies (e.g.; Sprague & Drury, 1969; Lewis & Livingston, 1977; Myllyvirta & Vuorinen, 1989). Limited recent information exists on the avoidance response of fishes to modern mill effluents. *In situ* bioassays have demonstrated that juveniles of some fish species, which by nature are surface water orientated, exhibited avoidance to surface waters receiving bleached mill effluents (McGreer & Vigers, 1983; Birtwell & Kruzynski, 1989). Other *in situ* bioassays and field studies have observed both avoidance and preference behaviour by fishes exposed to BKMEs (Kelso, 1977; McGreer & Vigers, 1983; Birtwell & Kruzynski, 1989). Much of the work indicates that the level of response is highly dependant on the species utilised and the specific characteristics of the mill effluent in question.

The avoidance responses observed in the present study were perhaps somewhat unexpected given that over at least the last decade, annual rainbow trout (*Oncorhynchus mykiss*) lethality experiments using swim-up fry have failed to show any acute toxicity (i.e. 96-h LC50 > 100% effluent) of this particular effluent (M.R van den Heuvel; M.J. Landman unpublished data). Furthermore, recent mesocosm exposures and *in situ* field experiments have revealed a lack of or only minor responses in exposed fish (Ellis et al., 2004; van den Heuvel et al., 2004; van den Heuvel et al., 2006). Regardless of toxicity, pulp and paper mill effluents consist of a complex chemical mixture associated with the manufacturing process. Whole effluent was utilised in the present study, and therefore the specific component(s) responsible for the avoidance response cannot be determined. The specific conductance, as well as chemical components of the wastewater (i.e. resin acids) were much higher compared to the control river water and may be linked to the sensory cue that induced avoidance, but this remains speculative until additional research is carried out.

The results of the current study may provide further insight to the distribution patterns of amphidromous common bully in the Tarawera River. Tasman mill effluent enters the river through a series of four submerged pipes (Nick Eynon-Richards, CHH Tasman Environmental Manger, pers. comm.), and when well-mixed with the river water, generally does not exceed a total dilution concentration of 10-15% v/v. Laboratory examination observed no avoidance response of common bully to final mill effluent at or below 25% concentration, which is further supported by the presence of amphidromous recruits to the lower section of the river. Avoidance of high effluent concentration in the laboratory may suggest the potential of a similar reaction to occur at the discharge outfall where concentrated final mill effluent first enters the river. If an avoidance response is occurring within the discharge zone, this could be responsible for the restricted movement of amphidromous common bully to the upstream site.

When extrapolating laboratory findings to the effluent-receiving environment, several other factors must be considered such as the diversity of physical and chemical conditions in natural systems. Mixing zone characteristics could include changes in temperature, turbulence/flow rate, and suspended solids, all of which may act on fish behaviour. Exposure of benthic species to sediments in pulp mill receiving environments may also be a confounding factor. Pulp and

paper mill effluent-derived resin acids are known to accumulate in sediments where they may undergo transformation into more recalcitrant lipophilic compounds such as retene (Judd et al. 1996; Tavendale 1997a; 1997b). These resin acid-derived compounds are known to be present in the Tarawera River sediments (Judd et al. 1996; van den Heuvel et al., 2006).

Biological variables should also be considered when extrapolating the current results. Motivational drive of migration may override avoidance reactions. Acclimation history of the test organism may decrease response to contaminants through sensory adaptation or habituation. Myllyvirta & Vuorinen (1989) reported avoidance of effluent-naïve vendace (*Coregonus albula* L.) to BKME. However, 1-week pre-exposure of fish to effluents resulted in preference for contaminated water over reference water. Different life stages of the same species may be more or less sensitive to a given contaminant (Little et al., 1993). The return migration of amphidromous common bully into freshwater occurs during the post-larval to early juvenile stage, and thus may represent a more sensitive and biologically relevant testing phase for avoidance.

An alternate hypothesis for the lack of diadromous recruitment to the upstream Tarawera may be explained by some other influencing factor in the river. The Tarawera River is a recipient for various natural and anthropogenic discharges (i.e. agricultural, geothermal and sewage wastes). A concurrent study identified a distinct increase in geothermal elements (Li, B, As, Hg) and some heavy metals (Cr, Fe) between the upstream and downstream section of the river, which could further influence movement patterns of common bully in the river.

Clearly then further research is required to confirm the cause of the absence of diadromous recruits to the upstream Tarawera River site and to rule out potential environmental and biological confounding variables which may influence the behavioural response. In future, it is recommended that the present study be repeated using atypical mill effluent (i.e. when furnish is switched from pine to eucalypt) to account for temporal variation in effluent quality. Conductivity should be investigated as a potential initiator of avoidance. The effects of effluent pre-exposure should also be examined. In addition, other natural and anthropogenic discharges to the river system could be looked at as potential barriers to migration. Juvenile fish should be included in these studies as this may represent the most relevant and sensitive life-history stage.

## **Chapter Four**

### **Pulp and paper mill effluent impact assessment**

## 4.1 Introduction

Globally, the pulp and paper industry has aimed considerable effort toward reducing toxicity and improving the quality of effluent discharged to aquatic environments. Although mill modernisation initiatives and wastewater treatment technologies have eliminated acute toxicity associated with effluent exposure, sub-lethal effects in fish continue to be reported in both laboratory and field studies of many modern mill effluents to date. Sublethal stresses caused by contaminant exposure may impact on important life processes such as growth, immunocompetence, and reproduction. Biochemical and physiological indicators (biomarkers) of exposure and response are frequently employed to assess these sublethal impacts and can provide early warning signs of adverse effects as well as an important link between laboratory and field observations. A well-established and highly sensitive biomarker of exposure to pulp mill derived contaminants is the measurement of liver mixed function oxidases (MFOs), often analysed by ethoxyresorufin-*O*-deethylase (EROD) activity. The causative agent of this response has been linked to biodegradation products of resin acids (Munkittrick et al., 1994; Martel et al., 1996; Orrego et al., 2006).

Reproductive impacts that have been observed in fish include changes in gonad size (Munkittrick et al. 1992; Gagnon et al., 1995), fecundity (Rickwood et al., 2006), secondary sexual characteristics (Parrot et al., 2004), vitellogenin induction in males (Tremblay & van der Kraak, 1999), and impaired biosynthesis of sex steroid hormones (McMaster et al., 1996; Landman et al., in press). Sex steroid hormones are derived from cholesterol and synthesised by the gonads in response to gonadotropin hormones (Schmitt & Dethloff, 2000). In mature fish, these hormones play an important role in reproductive functions such as gametogenesis, ovulation, and spermiation (Barry et al., 1990; Redding and Patino, 1993). Measurement of the reproductive hormones testosterone and estradiol in plasma, or in their biosyntheses by the gonadal tissues can provide a method for detecting potential contaminant-induced biochemical alterations of the endocrine system (McMaster et al., 1992, 1995). Decreased sex steroid levels in effluent exposed fish has been tentatively linked to wood-based phytosterols, such as  $\beta$ -sitosterol (Leusch & MacLatchy, 2003), and breakdown products of lignin (Hewitt et al., 2002).

The Tarawera River is the receiving environment for an integrated thermomechanical/bleached kraft (TMP/BK) pulp and paper mill effluent. Dedicated mesocosm and laboratory-based research of these effluents in the past have revealed a wide variety of exposure-related effects in fish (van den Heuvel & Ellis, 2002; van den Heuvel et al., 2002; Ellis et al., 2003). However, these effects have largely disappeared in recent years coinciding with mill process changes and improved effluent quality (van den Heuvel et al., 2004; Ellis et al., 2004). Contrary to those findings was a more recent 21-d in situ caging experiment using shortfin eel (*Anguilla australis*) within the Tarawera River, which observed a continuation of significant effects such as induced hepatic MFO (ethoxyresorufin-*O*-deethylase, EROD) activity, and changes in circulating sex steroid levels in effluent-exposed fish relative to an upstream control (van den Heuvel et al., 2006). From this work, questions were raised regarding potential effects associated with prolonged exposure of resident fish assemblages.

Environmental effects-based monitoring through field assessments has gained increasing use in validating components of laboratory studies, as well as to monitor and assess the health and integrity of biota in polluted waterways. The small-bodied, endemic common bully is recognised as an effective sentinel species for environmental monitoring in NZ because of their abundance and widespread applicability to many freshwater systems (Trembley et al. 2005). This species is known to exhibit high site fidelity as adults and thus reflect local environmental conditions, and their benthic nature ensures exposure to both water and sediments within a given system (West, 2006; van den Heuvel et al., 2007). An initial attempt to monitor resident fish health in the Tarawera River compared a downstream effluent exposed population of common bully to an upstream reference population and observed differences in reproductive timing, precluding use of the upstream site for purposes of comparison (van den Heuvel et al., 2007). Following the establishment of similar seasonal reproductive development between downstream Tarawera and downstream Rangitaiki common bully populations (Chapter 2), the aim of the current study was to conduct a wild fish health assessment, substituting the DR as a reference site, to investigate effects of long-term pulp and paper mill effluent exposure in situ. To attain an overall view of individual fish health, a selection of biomarkers were employed which were

directed across several levels of biological organisation, including; organism (condition factor), physiological (organosomatic indices – liver, spleen, and gonads), biochemical (EROD), immunological (haematology), and reproductive (gonadal steroid production, gonadal carotenoid levels) endpoints.

## 4.2 Materials and methods

### 4.2.1 Study site and fish capture

An impact assessment was undertaken at the end of July 2007. Sampling time for the impact assessment was chosen to proceed common bully spawning so that reproductive endpoints could be measured.

The Tarawera River site (DT) was located downstream of the pulp and paper mill influence and was chosen to represent an effluent-exposed site. The reference site (DR) for this study was located in the downstream Rangitaiki River following the findings of previous studies (van den Heuvel et al., 2007; Chapter 2). Site locations roughly matched each other in terms of inland distance. For sample site locations refer to the map presented in Chapter 1, Fig. 1.1. Approximately 40 adult fish (20 male, 20 female) per site were captured using minnow traps set overnight. Captured fish were transported back to the laboratory in 20 L plastic pails within two hours of capture and held in aerated river water prior to necropsy.

### 4.2.2 Sampling protocol

Fish were anaesthetised (0.1 g/L MS-222, Sigma-Aldridge) prior to being weighed, measured and necropsied. Approximately 30-100  $\mu$ L of blood was taken by caudal venipuncture (Plate 4.1) using pre-heparinised (5,000 i.u./mL) 0.5 mL tuberculin syringes and stored on ice until processed. Fish were subsequently sacrificed by an anaesthetic overdose. Fish were individually measured for body weight ( $\pm$  0.01 g), total length ( $\pm$  1.0 mm), organ mass (liver, gonad, spleen;  $\pm$  0.001g) and carcass weight ( $\pm$  0.01 g). Livers were removed, weighed and frozen in liquid nitrogen for biochemical analysis. Ovaries were sampled and stored for later carotenoid analysis. A subsample of whole ovaries were selected for *in vitro* steroid production. Fish carcasses were stored frozen at -20°C in labelled Whirl-Pak™ bags (Nasco, USA).



Plate 4.1. Obtaining blood from common bully (*G. cotidianus*) through caudal venepuncture.

#### *4.2.3 Haematology*

Haematological variables were analysed for whole blood haemoglobin concentration (Hb), haematocrit (Hct), red blood cell count (RBCC), mean cell volume (MCV), mean cell haemoglobin (MCH), mean cell haemoglobin concentration (MCHC), white blood cell concentration (WBCC), and differential leukocyte counts.

##### *4.2.3.1 Haemoglobin*

Haemoglobin was determined by the cyanmethaemoglobin method as described by Dacie and Lewis (1991). Two micrometers of whole blood was added to 1.0 mL of Drabkin's reagent in a 1.5 mL centrifuge tube and mixed thoroughly. The supernatant was aspirated and its absorbance measured using a Metertek SP-830 spectrophotometer at 540 nm.

#### 4.2.3.2 Haematocrit

Haematocrit was determined using the microcapillary method. Well-mixed whole blood was drawn into 1-5  $\mu\text{L}$  micro-haematocrit tubes (Drummond Scientific Company, USA), sealed with critoseal and centrifuged for 5 min at 12,000 rpm. Hematocrit was calculated as the percentage of packed red cell volume.

#### 4.2.3.3 Flow cytometric analysis of whole blood

Total red (RBC) and white (WBC) blood cell counts were determined using flow cytometry (Scion Research, Rotorua). Anticoagulated whole blood (10  $\mu\text{L}$ ) was suspended in a TruCount tube (BD Biosciences) containing 3.986 ml minimum essential medium (Gibco) with 0.25% BSA (Sigma). The TruCount tube contained an accurately known pre-dosed number of fluorescent beads. Immediately after cell dispersion, 4  $\mu\text{L}$  of 0.5 mg/mL dihexyloxacarbocyanine, DiOC6(3) (Molecular Probes) in dimethylsulphoxide (Sigma) was added, and then the sample was incubated on ice for 30 min in the dark. Flow cytometry counts were performed on a FACSVantage SE DiVa flow cytometer (BD Biosciences) equipped with a 488 nm laser, powered at 300 mW. Forward scatter (FSC), side scatter (SSC) and fluorescence were measured in the 530/30 nm wavelength range (FL1). The detector photomultiplier voltages were set at 200, 300 and 500 mV respectively, and were viewed in logarithmic mode. Threshold was set at channel 1000 on the FSC detector. The instrument sheath fluid was IsoTon II (Beckman-Coulter). Sample flow was adjusted to yield a count rate of 2000 events/s. Data was displayed on SSC vs. FL1 dot plots, and gates were set around the RBC, WBC and fluorescent bead populations to define each group. A total of 500 fluorescent beads were counted. Cell count/mL for RBCs and WBCs was determined using the following formula:

$$\text{cells/ml} = \frac{\text{cell count} \times \text{total bead count (TruCount tube)}}{\text{actual bead count (500)} \times \text{blood volume (0.01 ml)}}$$

#### *4.2.3.4 Leukocyte Differential counts*

Blood smears were prepared using 2  $\mu$ L of well-mixed whole blood on glass slides. Air-dried smears were fixed in absolute methanol and stained with a Leishman-Giesma solution. The stained smears were cover-slipped using Clarion mounting medium (Sigma-Aldrich, Inc., USA), examined and photographed by light microscopy under oil emersion at 400x magnification. For each slide, areas were randomly chosen and 100 leukocytes were counted and differentiated into three different types (lymphocytes, granulocytes and thrombocytes) based on their morphology (Zinkl et al. 1991; Tavares-Dias 2006). The relative proportions of each cell type were averaged by site and sex.

#### *4.2.5 Ovarian carotenoid analysis*

Thawed individual whole ovaries were weighed (wet weight  $\pm$  0.001), and ground with 5 g anhydrous granular sodium sulphate (Merck, NZ) until homogeneous. Standard amounts of carotenoids in dichloromethane (Merck, NZ) were processed in the same way as above. 1, 2.5, 5 and 10  $\mu$ g amounts of canthaxanthin (Dr. Ehrenstorfer, Germany), lutein and astaxanthin (Sigma-Aldrich, NZ), and 5, 10, 25 and 50  $\mu$ g amounts of zeaxanthin (Sigma-Aldrich, NZ). The greater amounts of zeaxanthin used were necessary due to the comparatively lower colour intensity of this compound in the visible wavelength range.

Tissue homogenates were extracted using supercritical carbon dioxide using a Spe-ed SFE 4 extractor (Applied Separations, Allentown, PA, USA) under the following operating conditions: extraction pressure = 550 bar, vessel temperature = 500C, supercritical fluid flow = 3 L/min, elution time = 30 minutes. The extracts were collected on C18 solid phase extraction cartridges (Machery Nagel, Germany), eluted with 50:50 dichloromethane:acetonitrile (Merck, NZ) and evaporated to dryness under a stream of nitrogen gas. The residues were reconstituted in 1 mL of dichloromethane, filtered through a 0.45  $\mu$ m filter cartridge (Bonnet Equipment, NZ) and transferred to 4 mL glass WISP-style autosampler tubes fitted with low volume glass inserts. Analysis by high-performance liquid chromatography (HPLC) was performed on a Gilson (USA)

HPLC fitted with an Apollo Econosil 4.6 x 250 mm silica column (Alltech Associates Inc., NZ) and UV-visible detector. The mobile phase was 70:30 hexane:methanol (Merck, NZ), run isocratically at 1 mL/min. Injection volume was 20  $\mu$ L. Run time was 30 min. Detection was at 480 nm.

#### *4.2.6 In vitro ovarian steroid production*

Determination of *in vitro* steroid production by fish gonadal tissue was conducted on 10-13 female fish per site and analysed according to McMaster et al. (1995). This method has recently been validated for use with common bully (Landman et al., in press).

Using fine forceps, whole ovaries were removed from the fish and sectioned into roughly 6 equal sized pieces (20-50 mg each). Using 24-well tissue culture plates, the individual ovary pieces were immediately placed into separate wells with 500  $\mu$ L of chilled incubation medium (Medium 199, containing Hank's salts without bicarbonate supplemented with 25 mM Hepes, 4.0mM sodium bicarbonate, 0.01% streptomycin sulphate and 0.1% bovine serum albumin, pH 7.4). When a full plate was obtained (a total of 4 fish treatments) media was gently removed with a Pasteur pipette and replaced with 500  $\mu$ L of fresh Medium 199. In addition to this, 500  $\mu$ L of Medium 199 containing either 100 IU/mL human chorionic gonadotropin (hCG; Sigma-Aldrich, St. Louis MO, USA), 10  $\mu$ M forskolin (SIGMA) or no activator was added to each well. The treatment containing no activator, referred to as 'basal treatment' acted as a control. All treatments were conducted in duplicate. Samples were incubated at 18°C for 24 h. Following incubation, the medium was aspirated by Pasteur pipette, placed into labelled cryovials, snap-frozen in liquid nitrogen and stored at -85°C pending steroid analysis.

#### *4.2.7 Sex steroid analysis*

Concentrations of the steroid hormones testosterone (T) and 17 $\beta$ -estradiol (E2) released into the media during the incubation period were measured by the standard radioimmunoassay (RIA) procedure described by McMaster et al. (1995). Frozen incubation media was thawed and assayed directly on 200  $\mu$ L

aliquots for T (Sigma-Aldrich) and E2 (Sigma-Aldrich). Values were converted to correct for sub-sample size of the tissue analysed and expressed in pg/mg of gonadal tissue. Testosterone and estradiol antibodies were obtained from Valeant (Aliso Viejo, CA, USA). Titrated testosterone and estradiol were obtained from GE Healthcare (Little Chalfont, Buckinghamshire, UK).

#### *4.2.8 Ethoxyresorufin-O-deethylase (EROD) activity*

Frozen liver samples were couriered overnight to Landcare Research (Lincoln, NZ) for the analysis of liver mixed-function oxygenase (MFO) enzyme analysis as ethoxyresorufin-*O*-deethylase (EROD) activity on post-mitochondrial supernatant (PMS) using a modification of the fluorescence plate-reader described by van den Heuvel et al. (1995). Liver extracts were homogenized in ice-cold isotonic buffer (0.066 M K<sub>2</sub>HPO<sub>4</sub>, 0.033 M KH<sub>2</sub>PO<sub>4</sub>, 1mM EDTA, 20% glycerol, 1 mM dithiothreitol, 0.1 mM phenylmethylsulfonyl fluoride, pH 7.5) and spun at 10,000g for 20 min. The EROD reaction mixture contained 0.1 M Hepes buffer, pH 7.8 (Sigma), 5.0 mM Mg<sup>2+</sup>, 0.5 mM NADPH (Applichem, Darmstadt, Germany), 1.5 μM 7-ethoxyresorufin (Sigma), and roughly 0.5 mg/mL PMS protein. The EROD activity was determined kinetically in 96-well plates using one reading every min for 10 min on a BMG Fluostar fluorescence plate reader (BMG Labtechnologies, Offenburg, Germany). Resorufin was determined using 544-nm excitation and 590-nm emission filters. Protein content was estimated from fluorescamine fluorescence (390-nm excitation, 460-nm emission filters) against bovine serum albumin standards (Sigma).

#### *4.2.9 Water and sediment chemistry*

Water and sediment samples were collected from each sample site during the bimonthly sampling periods and analysed for organic extractives using standard methods according to Zender et al. (1994) and Tavendale et al. (1995), respectively.

On arrival at the laboratory water samples were frozen at -20°C pending analysis at Scion (Rotorua, NZ). Effluent samples were later thawed and 125mL of sample was adjusted to pH 9.0 with NaOH. Surrogate standards (2,4,6-

tribromoanisole, 2,4,6-tribromophenol, D10-anthracene, D31-palmitic acid, 8(14)-abietenic acid and dihydrocholesterol) were introduced immediately prior to extraction. Samples were continuously extracted with dichloromethane using glass liquid–liquid extractors. Extracts were passed through sodium sulphate and concentrated with nitrogen using a Zymark Turbovap. The final extract was silylated with bis(trimethylsilyl)-trifluoroacetamide plus 1% trichloromethylsilane and analyzed by gas chromatography with mass selective detection (GC-MSD). All analyte concentrations were corrected for extraction blanks and adjusted for the recovery of the appropriate surrogate standard).

Sediment samples were immediately frozen at -20°C on arrival at the laboratory pending analysis. Samples were later thawed and a 25 mL sub-sample of the sediment was frozen at -80°C, freeze-dried for 24 h and ground to a fine power using mortar and pestle. An accurately weighed 1 g ( $\pm$  0.001 g) subsample was then homogenized with 9 g of anhydrous granular sodium sulphate (Merck, NZ) using mortar and pestle and subjected to solid-liquid phase extraction using the same method as above.

#### *4.2.10 Statistics*

Comparison of mean site values for fish mass, liver size, spleen size and gonad size data were statistically analysed by analysis of covariance (ANCOVA) on logarithmically transformed variables with body size (length or weight) as the covariate. Body mass and organ size data are presented in terms of condition and somatic indices for ease of comparison. Condition factor = (fish mass – organ mass)/(total length<sup>3</sup>) x 100; liver somatic index (LSI) = liver mass/(fish mass – organ mass) x 100; spleen somatic index (SSI) = spleen mass/(fish mass – organ mass) x 100; gonadosomatic index (GSI) = gonad mass/(fish mass – organ mass) x 100. Remaining data were compared using analysis of variance (ANOVA) after log-transformation where departures from normality were observed. For data that did not conform to the assumptions of parametric analysis following log-transformation, a nonparametric Mann-Whitney U test was used. Because differential white blood cell counts were measured as proportions of the various cell types, these data were arcsine transformed prior to analysis (Sokal and Rolf, 1973). All statistical analyses were performed with STATISTICA v8.0 software

(Statsoft, Tulsa, OK, USA). The critical level of statistical significance for all tests was  $\alpha = 0.05$ .

### 4.3. Results

#### 4.3.1 Physiological indices

A summary of the physiological endpoints measured in common bully from the exposed and reference fish populations are presented in Table 4.1. The mean size of fish, as measured by length and weight, were slightly higher in males from the downstream Tarawera compared to the Rangitaiki. Female size range was similar between sites. No significant site differences were observed in condition factor, liver somatic index, or spleen somatic index. Gonadal development confirmed both populations were close to the onset of spawning, although the DT bullies were slightly more advanced than the Rangitaiki fish, with a mean GSI of 8.27% vs. 6.13%, for females and 0.95% vs. 0.62% for males, respectively.

Table 4.1. Mean ( $\pm$  SEM, n) of size and somatic indices in male and female common bully. Asterisks indicate significant difference ( $p < 0.05$ ) in ANOVA between sample sites.

Index	Site	
	Downstream Rangitaiki	Downstream Tarawera
<i>Males</i>		
Length (mm)	88.8 (2.49, 13)	98.0 (3.86, 19)*
Weight (g)	10.0 (1.19, 13)	14.4 (1.78, 19)*
Condition (K)	1.33 (0.04, 13)	1.33 (0.04, 19)
LSI	2.19 (0.22, 13)	2.12 (0.16, 19)
GSI	0.62 (0.10, 13)	0.95 (0.24, 19)*
<i>Females</i>		
Length (mm)	95.1 (1.77, 25)	93.2 (4.02, 20)
Weight (g)	12.3 (0.73, 25)	12.6 (1.64, 20)
Condition (K)	1.28 (0.02, 21)	1.25 (0.06, 14)
LSI	2.46 (0.11, 21)	3.06 (0.30, 14)
GSI	6.13 (0.48, 21)	8.27 (1.01, 14)*

### 4.3.1 Hematology

Haematological variables are presented in Table 4.2. There were no significant differences found for spleen somatic index, total white blood cell count or any other of the haematological parameters measured in male common bully between sites. Female bullies from the downstream Tarawera showed significantly lower ( $p < 0.05$ , ANOVA) mean cell haemoglobin (MCH) and mean cell volume (MCV) compared to reference females. Higher total white blood cell counts were also observed in these fish.

White blood cells were characterised by light microscopy into three groups based on their morphology (Plate 4.2). Mean differential counts were consistent irrespective of site and sex. For both fish populations lymphocytes were the dominant WBC type (range 50~59%). Granulocytes and thrombocytes existed in approximately similar proportions to each other.

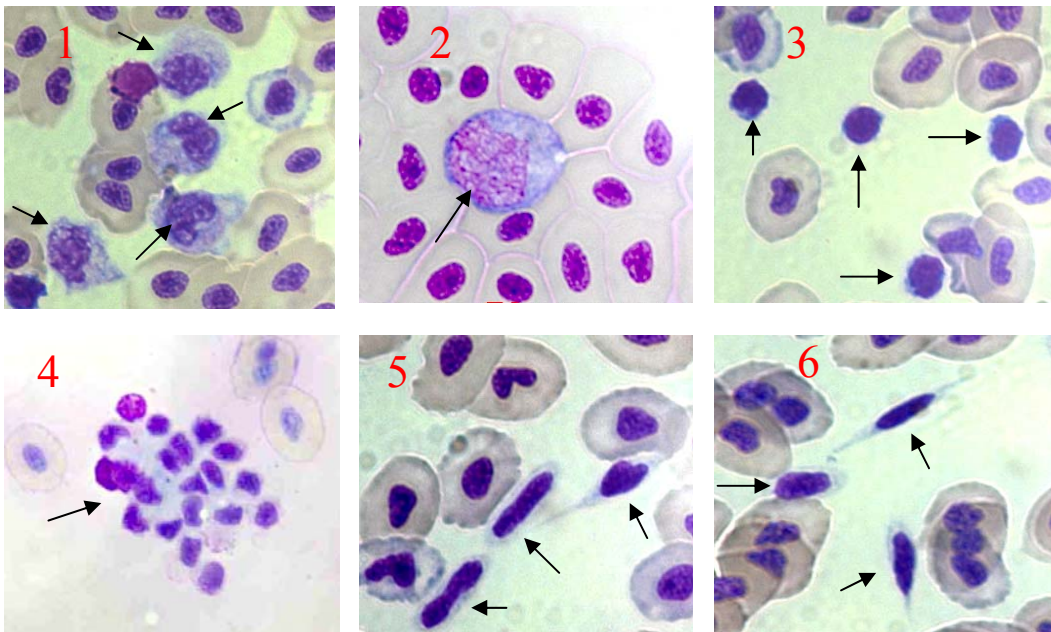

Plate 4.2. Blood cell characterisation of common bully (*G. cotidianus*). Arrows point to; granulocytes (1,2), lymphocytes (3), and thrombocytes (clustered, spindle & rods) (4,5,6). All background cells are red blood cells (erythrocytes).

Table 4.2. Mean ( $\pm$  SEM,  $n$ ) blood parameters for male and female common bully. Asterisks indicate significant difference ( $p < 0.05$ ) in ANOVA between site parameters.

Parameter	Site	
	Downstream Rangitaiki	Downstream Tarawera
<i>Males</i>		
Hematocrit (%)	20.0 (1.52, 13)	18.9 (1.31, 21)
Red Blood cells (cells/L x 10 <sup>12</sup> )	1.27 (0.05, 13)	1.24 (0.08, 21)
Mean cell volume (fl)	157 (9.31, 13)	151 (4.95, 21)
Hemoglobin concentration (g/L)	40.8 (2.33, 13)	38.7 (2.65, 21)
Mean cell hemoglobin (pg/cell)	32.2 (1.45, 13)	32.0 (1.65, 21)
Mean cell hemoglobin concentration (g/L)	215 (16.9, 13)	220 (17.2, 21)
White blood cells (cells/L x 10 <sup>10</sup> )	3.78 (0.63, 13)	3.71 (0.63, 21)
Granulocytes (%)	15.9 (3.69, 12)	22.2 (2.80, 21)
Lymphocytes (%)	59.0 (4.13, 12)	57.8 (2.40, 21)
Thrombocytes (%)	26.8 (2.31, 12)	22.2 (1.80, 21)
Spleen somatic index	0.14 (0.02, 12)	0.14 (0.02, 17)
<i>Females</i>		
Hematocrit (%)	20.9 (1.09, 25)	20.0 (1.52, 23)
Red Blood cells (cells/L x 10 <sup>12</sup> )	1.25 (0.05, 25)	1.37 (0.06, 23)
Mean cell volume (fl)	169 (6.95, 25)	146 (4.50, 23)*
Hemoglobin concentration (g/L)	40.1 (1.43, 25)	40.5 (1.92, 23)
Mean cell hemoglobin (pg/cell)	32.5 (0.82, 25)	29.7 (0.89, 23)*
Mean cell hemoglobin concentration (g/L)	198 (7.22, 25)	207 (7.52, 23)
White blood cells (cells/L x 10 <sup>10</sup> )	2.80 (0.18, 25)	3.47 (0.28, 23)*
Granulocytes (%)	28.6 (2.74, 25)	22.9 (3.23, 20)
Lymphocytes (%)	50.8 (1.95, 25)	55.7 (3.03, 20)
Thrombocytes (%)	22.3 (1.46, 25)	25.6 (1.60, 20)
Spleen somatic index	0.13 (0.01, 18)	0.13 (0.02, 15)

#### 4.3.6 Ethoxyresorufin-*O*-deethylase (EROD) activity

Hepatic EROD activity was measured as an indicator of exposure to pulp mill related compounds. Significant differences ( $p < 0.05$ ) in EROD activity was observed between the sample sites (Fig. 4.3), with the effluent exposed fish showing an approximate 6-9 fold induction compared to the reference site fish (mean of 3.81 vs.0.53 pmol/mg/min in females and 5.11 vs. 0.55 pmol/mg/min for males, respectively).

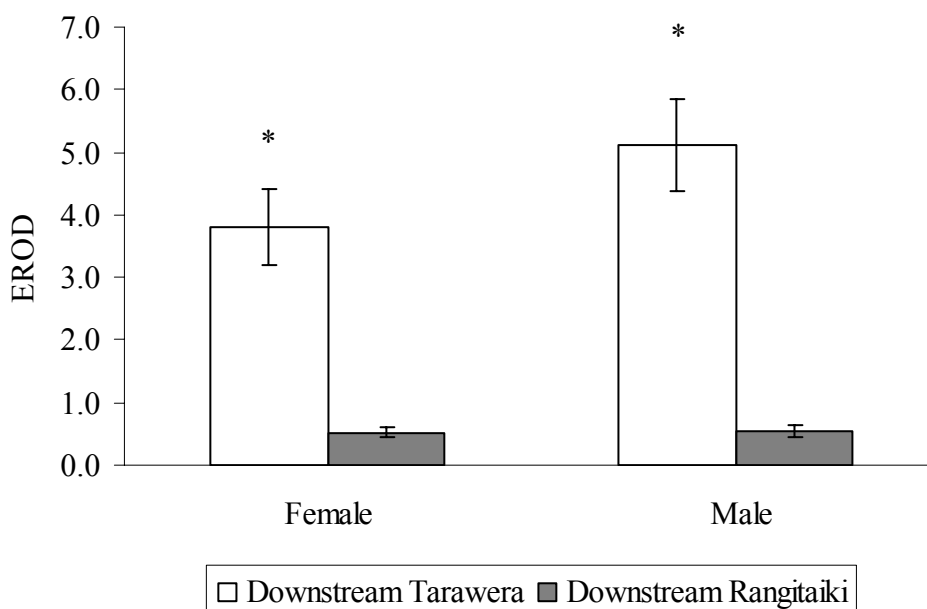

Figure 4.1. Mean hepatic ethoxyresorufin-*O*-deethylase (EROD) activity (pmol/resorufin/mg/min) in male and female common bully from the downstream Tarawera and the downstream Rangitaiki (reference). Error bars represent SEM; \* =  $p < 0.05$ .  $N_{\text{Female}} = 11$  (DT) and 14 (DR).  $N_{\text{Male}} = 7$  (DT), 4 (DR).

#### 4.3.4 Ovarian steroid production

*In vitro* steroid production of T and E2 in ovarian tissue are presented in Fig. 4A and B. No significant site differences were observed for control basal treatments for either sex steroid. Steroid production in both populations generally

increased with activation by forskolin and hCG compared to basal incubation conditions (i.e. no activator). For both T and E2 there were significant differences between treatments. For T there was a significant ( $p < 0.05$ ) site difference and a near significant ( $p = 0.057$ ) difference for E2. Induction of testosterone by both forskolin and hCG was 2-3 times higher in the effluent exposed Tarawera females compared to the Rangitaiki reference fish (Fig. 4.2A). Similarly, the ability of exposed fish to produce estradiol *in vitro* through activation of forskolin was also slightly higher than the reference fish, although no difference was observed between sites with hCG activation of estradiol (Fig. 4.2B). In general, the induction of sex steroids appeared to be significantly higher in fish ovaries sampled from the effluent-exposed Tarawera site.

#### 4.3.3 Ovarian carotenoid analysis

Carotenoid analysis using SFE and HPLC was unsuccessful in this study. Retention times of the standards canthaxanthin, astaxanthin, lutein and zeaxanthin were 4.4, 6.4, 8.1 and 8.4 minutes respectively, and recoveries were between 38 and 42%. Very low carotenoid recoveries were observed for the ovary samples, with most samples yielding no detectable peaks of the four carotenoid standards (data not shown). As the standard curve ranges encompassed carotenoid amounts observed in previously analysed common bully ovaries using solvent extraction (Landman et al., in press), it is uncertain why recovery using supercritical fluid extraction (SFE) was compromised. Carotenoids are highly oxidative and unstable compounds. Thus, it is assumed that cross-reaction between carotenoids and tissue components may have occurred under the SFE conditions. Alternatively, the high temperature and pressure conditions associated with SFE may have compromised the samples. In future investigations, it is recommended that ovarian carotenoid analysis be performed according to the method described by Landman et al. (in press).

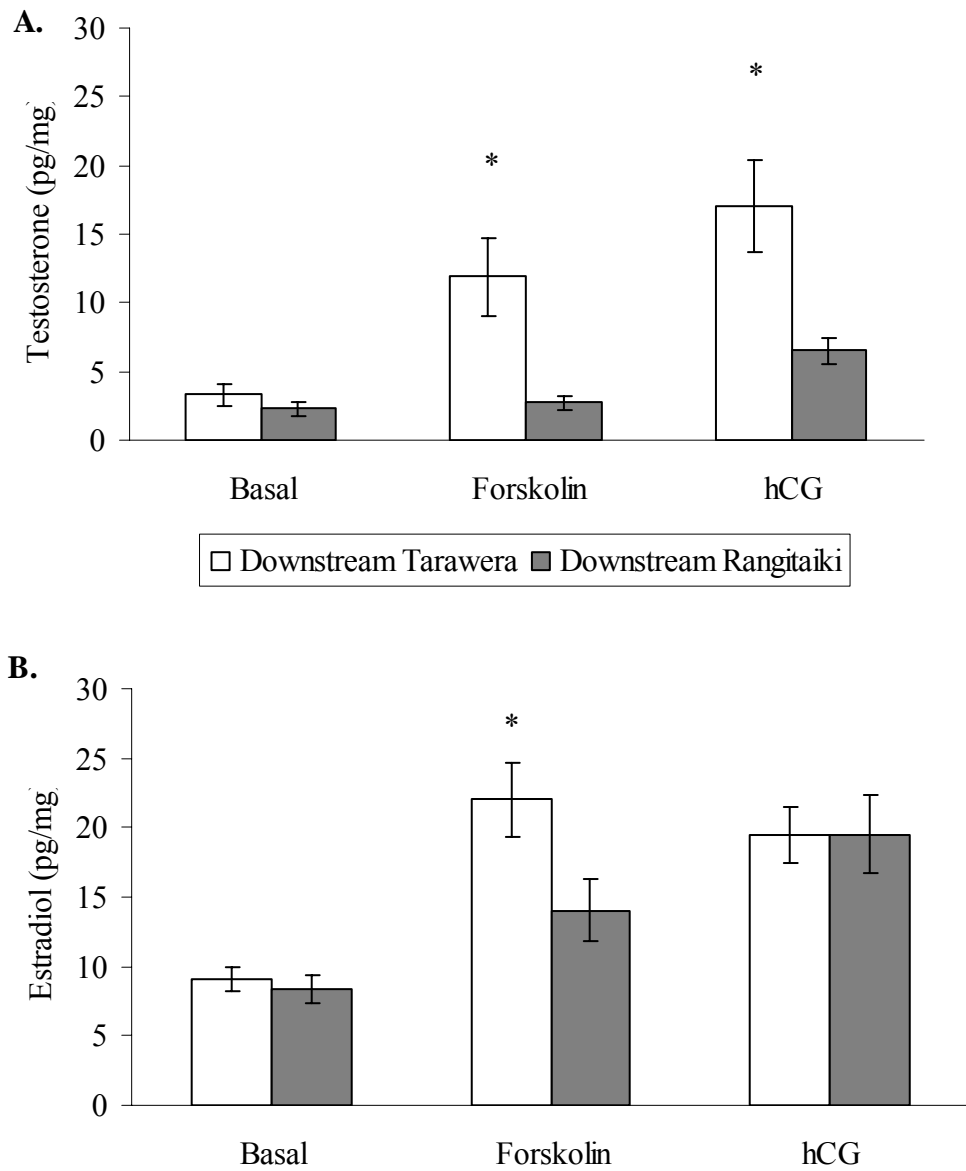

Figure 4.2. In vitro steroid production of A) testosterone and B) estradiol from ovarian follicles. Steroid values are mean  $\pm$  SEM concentrations (pg/mg). N DT = 13, N DR = 10. All samples were carried out in duplicate.

#### *4.3.7 Water and sediment chemistry*

Water and sediment organic extractives chemistry for each sample site are given in Tables 4.3 and 4.4, respectively. Organic chemistry of the downstream Tarawera site reflected the relative inputs into the river system from the pulp and paper mills, showing high variation in chemical components compared to the Rangitaiki reference site. Temporal variation was evident between sampling periods. Both river sites contained measurable amounts of fatty acids and untransformed resin acids. The Tarawera River water was characteristic of a system receiving pulp and paper mill effluent, having much higher levels of resin acids, namely abietic acid and dehydroabietic acid, plant sterols (sitosterol and sitostanol), and phenolics (vanillin). Resin acid neutrals were not detected in either river water samples, but were measured in downstream Tarawera sediment samples. Resin acid neutrals were dominated by retene and tetrahydroretene. Traces of resin acid neutrals were also observed in the upstream Tarawera River sediments, though in much smaller amounts compared to the downstream river.

Table 4.3. Organic extractives for river water samples collected from the downstream Tarawera and Rangitaiki Rivers sampling sites. Concentrations ( $\mu\text{g/L.}$ ) are presented for each major compound class analysed.

Compound class	Downstream Rangitaiki				Downstream Tarawera			
	January	May	July	September	January	May	July	September
Phenolics	<b>n.d.</b>	<b>n.d.</b>	<b>n.d.</b>	<b>n.d.</b>	<b>0.02</b>	<b>n.d.</b>	<b>n.d.</b>	<b>n.d.</b>
Fatty Acids	<b>430</b>	<b>157</b>	<b>17.7</b>	<b>12.1</b>	<b>466</b>	<b>8.54</b>	<b>5.25</b>	<b>17.0</b>
Resin Acid Neutrals	<b>n.d.</b>	<b>n.d.</b>	<b>n.d.</b>	<b>n.d.</b>	<b>n.d.</b>	<b>n.d.</b>	<b>n.d.</b>	<b>n.d.</b>
Resin Acids	<b>14.3</b>	<b>7.24</b>	<b>5.93</b>	<b>6.32</b>	<b>47.3</b>	<b>42.4</b>	<b>55.9</b>	<b>62.7</b>
Phytosterols	<b>n.d.</b>	<b>n.d.</b>	<b>n.d.</b>	<b>n.d.</b>	<b>n.d.</b>	<b>2.07</b>	<b>n.d.</b>	<b>4.79</b>
<b>Total Extractives</b>	<b>444</b>	<b>164</b>	<b>23.6</b>	<b>18.5</b>	<b>514</b>	<b>51.0</b>	<b>61.1</b>	<b>79.7</b>

Table 4.4. Organic extractives for sediment samples from the Tarawera and Rangitaiki River sampling sites. Also included was an upstream reference for each river system. Concentrations ( $\mu\text{g/g}$  dry sediment) are presented for each major compound class analysed.

Compound class	Rangitaiki River				Tarawera River			
	Downstream			Upstream	Downstream			Upstream
	May	July	September	July	May	July	September	July
Phenolics	<b>0.28</b>	<b>0.15</b>	<b>0.26</b>	<b>0.12</b>	<b>0.15</b>	<b>0.05</b>	<b>0.28</b>	<b>0.16</b>
Fatty Acids	<b>6.06</b>	<b>40.3</b>	<b>108</b>	<b>2.38</b>	<b>6.02</b>	<b>2.55</b>	<b>18.0</b>	<b>0.92</b>
Resin Acid Neutrals	<b>n.d.</b>	<b>n.d.</b>	<b>n.d.</b>	<b>n.d.</b>	<b>8.87</b>	<b>1.87</b>	<b>4.98</b>	<b>0.98</b>
Resin Acids	<b>4.61</b>	<b>2.55</b>	<b>3.10</b>	<b>1.57</b>	<b>151</b>	<b>52.7</b>	<b>249</b>	<b>5.32</b>
Phytosterols	<b>5.99</b>	<b>55.5</b>	<b>77.4</b>	<b>10.3</b>	<b>36.4</b>	<b>21.9</b>	<b>98.2</b>	<b>n.d.</b>
<b>Total Extractives</b>	<b>16.9</b>	<b>98.5</b>	<b>188</b>	<b>14.3</b>	<b>203</b>	<b>79.1</b>	<b>370</b>	<b>7.38</b>

*Note.* n.d. = not detected, method detection limit is 0.01  $\mu\text{g/g}$ .

### 4.3 Discussion

Resident wild common bully captured downstream of the mill outfall in the Tarawera River showed some characteristic evidence of exposure to pulp and paper effluent. A significant 6-9 fold induction of liver detoxification enzymes (EROD) were exhibited in fish below the mill. Condition factor and organo-somatic indices (LSI, SSI) were very similar between sites, although the Tarawera fish population appeared to be slightly more advanced in reproductive development based on GSI. In addition, exposed females showed variation in some haematological variables and slight differences in gonadal sex steroid production compared to the reference fish.

An understanding of the basic biology and life-history of small-bodied fishes is important for study design and data interpretation for their use in environmental monitoring (Galloway & Munkittrick, 2006). In an attempt to minimise potential confounding factors for the present study, initial work confirmed similarity in biotic variables including genetic structure, reproductive timing and life cycle characteristics (i.e. amphidromous life-history) between the exposed Tarawera common bully population and the chosen reference (van den Heuvel et al., 2007; Michel et al., 2008; Chapter 2). In addition, prolonged exposure history of adult common bully to site characteristics was inferred through distinctive isotopic signatures of C and N in fish flesh (Chapter 2), supporting residence of small-bodied fishes as seen in other studies (Gray et al., 2004). This method has previously utilised for common bully and has proven to be a reliable indicator of effluent exposure (West, 2006; van den Heuvel et al., 2007; Landman et al., in press).

Biochemical responses of fish, including the induction of EROD has been widely used as a bioindicator to pulp mill contaminants. Although the consequence of EROD induction on fish health is largely unknown, the compound(s) responsible are believed to be products of wood-derived resin acids contained within the effluent. As expected, common bully captured from below the mill outfall in the Tarawera River showed significantly higher EROD activity compared to the reference population. This was expected and compared well with previous assessment of wild common bully in the river which showed an approximate 3-fold induction compared to upstream reference fish (van den

Heuvel et al., 2007). An *in situ* experiment within this system has also shown induction of EROD in caged shortfin eel (*Anguilla australis*), which was accompanied by high concentration of retene and pyrene equivalents in bile extracts (van den Heuvel et al., 2006). van den Heuvel et al., (2006) suggested that increased EROD activity in fish below the mill was most likely caused through exposure to contaminated sediments, suggesting a causal relationship between PAH exposure and EROD induction. This was largely assumed because mesocosm exposures of rainbow trout (*Oncorhynchus mykiss*) to this same effluent no longer show significant EROD induction (van den Heuvel et al., 2004; Ellis et al., 2004). The PAH retene is known to be formed under anaerobic conditions through microbial transformation of the resin acid dehydroabietic acid (Tavendale et al., 1997a, b), such as may occur in the sediments of the receiving system. Retene in particular has shown to be bioavailable to benthic fish (Leppanen & Oikari, 1999), and the demersal nature of common bully could make this species particularly sensitive to sediment exposure. Chemical data from the current study may further support this theory in that while high levels of resin acids were found in the downstream Tarawera River water samples, only resin acid neutrals were found in the downstream Tarawera sediment. Some other studies have reported a paralleled increase in liver size (LSI) associated with EROD induction (Larsson et al., 1988), but no such effect was observed in the present study.

Indicators of energy storage (condition factor and liver size) were similar between sites. In terms of physiology, condition factor may reflect the integrated effects of nutritional status and metabolic stress (Adams & McLean, 1985). Condition of fish may be expected to decrease under adverse stressful conditions. Large body size accompanied by high condition factor observed in the effluent exposed fish, as well as the reference population, is likely linked to high productivity of these river systems. Elevated condition is a commonly reported for fish inhabiting pulp mill receiving systems as a factor of increased nutrients and water temperature associated with effluent discharges (Munkittrick et al., 1994, Karels et al., 1998). Deviation in reproductive state between the two sites, as indicated by the mean site GSI, was most likely a factor of natural variation in spawning period. Numerous studies of common bully throughout NZ have reported differences in reproductive timing both within and between different freshwater systems (Chapter 2) which could be linked to a number of

environmental or biological factors. Thus, the variation in GSI in the current study was not considered to be directly linked to effluent exposure.

Blood parameters may vary as a result of either stress or adaptation. General haematological values in the present study were slightly lower than those previously reported for common bully (West, 2006; Landman & Ling, 2006; Landman et al., 2007). This in itself is not of high significance given that haematology of fish has been shown to vary with numerous biological and environmental factors. For instance, West (2006) observed differences in blood parameters between river and lake populations of common bully, and Landman & Ling (2006) observed changes in haematology in relation to reproductive state, and also noted the possibility of changes related to allometric size differences as observed in another species (*Basilichthys australis*; Nespolo & Rosenmann, 2002). In terms of the current study, haematology was relatively consistent between the exposed and reference fish, with the exception of the downstream Tarawera females. An increase of white blood cells may be suggestive of an immune response, as has often been associated with infection or disease. However, no alteration was observed in differential white blood cell types. Significantly decreased MCH and MCV was perplexing in that it is unusual to see changes in these secondary hematological measures without observing corresponding changes in Hct, Hb and/or RBCC. Changes in the latter have commonly been observed in fish inhabiting BKME receiving waters, often associated with low DO in these systems or increased water temperature (West 2006). Common bully are known to be relatively tolerant low DO conditions (Landman et al. 2005) such as may occur in the downstream Tarawera River (Dell et al., 1996). Furthermore, interactions between low DO and effluent exposure were not observed during acute laboratory exposures (Landman et al., 2004).

Reproductive effects of pulp and paper mill effluents have been well documented, with a common observation being a decline in the concentration of circulating sex steroids or impairment of their synthesis (Adams et al., 1992; Gagnon et al., 1994; McMaster et al., 1995, 1996; Munkittrick et al., 1998). A consequence of decreased levels of these steroids may result in impaired reproductive fitness (McMaster et al., 1995).

An impact assessment of common bully from another pulp mill receiving system in NZ recently reported decreased ovarian follicular steroid production of

exposed fish, as well as decreased carotenoid levels in ovarian tissue (Landman et al., in press). Unfortunately, further method development using SFE for the analysis of ovarian carotenoids in the current study proved to be ineffective, therefore ovarian carotenoid content could not be determined. However, contrary to previous studies, *in vitro* incubations of ovarian follicles revealed that effluent-exposed fish appeared to have an increased ability to produce the sex steroids T and E2 compared to reference fish. This finding is similar to the recent shortfin eel caging study performed in the Tarawera River where increased levels of circulating T and E2 were observed in effluent-exposed fish caged downstream of the pulp and paper mill effluent discharge (van den Heuvel et al., 2006). However, these authors could not definitively link the steroid effect to contaminant exposure, as these hormones are known to respond to stress in a non-specific manner. Thus, van den Heuvel et al. (2006) suggested a possible link with reduced circulating steroids and increased caging stress in reference fish, although differences in the physiological stress response was not established for fish between caging sites.

The results of the current study are cautiously interpreted. It is implied that some form of endocrine alteration in the effluent-exposed female fish compared to the Rangitaiki River fish was evident, although not necessarily related to effluent exposure or indicative of an adverse effect. In any case, these results appear to be site specific and not typical of pulp and paper mill exposure. The observed response could potentially be due to some other influence source in the river (i.e. sewage, agricultural, geothermal wastes). Alternatively, McMaster (1995) pointed out that even slight variability in reproductive synchrony between paired fish populations can result in marked differences in the steroids produced in the *in vitro* incubation procedure. Thus the observed response may merely be a factor of differences in gonadal development stage as indicated by the mean site GSI. Between-site differences are difficult to interpret without further investigation.

This study assessed the long-term impacts of a modern pulp and paper mill discharge and other contaminants on a wild native New Zealand fish species inhabiting the receiving waterway. Common bully proved to be an effective test organism for use in environmental assessment to aquatic contaminants. Collectively, the results from this study showed an indication of exposure and response of the resident fish to contaminants contained in, or derived from the

pulp mill discharges entering the river. However, no apparent decline to either general fish health, or reproductive fitness was inferred comparable to the reference. Discrepancies between field-based effects compared to previous laboratory experiments, which had reported elimination of reproductive and biochemical responses in fish to these mill effluents a number of years ago, can possibly be attributed to exposure of wild fish to contaminated sediments within the receiving system. Future research is warranted to investigate these causal relationships.

The results of this investigation will contribute to a larger body of research aimed at assessing the biotic impacts of effluent discharges to the Tarawera River through tracking ongoing changes and improvements of this mill effluent. In addition, findings from this study can be used in future investigations by acting as a benchmark to which to assess further potential developments on the river system.

# **Chapter Five**

## **General Conclusions**

This thesis examined the ecology and physiology of common bully (*Gobiomorphus cotidianus*) populations within the Tarawera and Rangitaiki Rivers. The Tarawera River is a heavily modified and degraded system that receives numerous industrial, municipal and natural inputs. Particular emphasis of this thesis was based on the relative influence of an integrated thermomechanical/bleached kraft (TMP/BK) pulp and paper mill effluent to affect the migratory patterns, reproductive fitness and health of wild common bully inhabiting the receiving waterway of these discharges.

Previous field surveys conducted within the Tarawera River had reported reproductively, genetically, and morphologically distinct subpopulations of common bully inhabiting the upstream and downstream river reaches (van den Heuvel et al., 2007; Michel et al., 2008). In addition to this, a lack of diadromous immigration to the upstream site suggested an isolation mechanism in the absence of obvious physical barriers to fish migration. Common bully are facultatively diadromous (Closs et al., 2003), and it remained unclear whether those differences observed were a natural progression associated with inland river distance or due to some other influencing factor in the river.

To address these research questions, Chapter 2 investigated the distribution of amphidromous and non-amphidromous common bully in an upstream and downstream reach of the Tarawera River, in comparison to outgroup samples from the adjacent Rangitaiki River. All sample sites had open access to the sea, with no physical barriers to migration. It was hypothesised that if a loss of diadromy was primarily due to inland distance, then a similar pattern of migratory types should occur in the Rangitaiki fish populations.

Otolith microchemistry distinguished migratory from non-migratory stocks, and stable isotope analysis ensured long-term site residency of adult fish. To test for potential morphological variation between migratory types, otolith data was contrasted with vertebral counts and the distribution of oculoscapular canal morphotypes. Temporal reproductive divergence was investigated through tracking annual trends in gonadosomatic index.

The results from this study revealed dominance of amphidromous fish with full oculoscapular canal structures in both downstream river reaches, whereas a loss of diadromy and reduced canal structures was evident in the two upstream river sites. Spatial and temporal differences in reproductive timing were

also evident between paired river sites. Downstream populations showed evidence of discrete winter spawning, while the presence of gravid females throughout July through to January in the two upstream sites suggested a protracted spawning season. Concurring with previous observations, otolith microchemistry confirmed a lack of diadromous recruitment to the UT. A mixture of both diadromous and non-diadromous migratory types in the UR site concluded that distance was unlikely the sole factor influencing inland penetration of marine migrants in the Tarawera system.

A logical hypothesis that arose from Chapter 2 was the possibility that, as a significant discharge entering the Tarawera River, pulp and paper mill effluent may be acting as a chemical barrier to fish distribution. A laboratory behavioural study (Chapter 3) employed a choice-chamber system to determine preference/avoidance response of common bully exposed to simultaneous concentrations of TMP/BKME (100, 50, 25, 25.5, and 0% v/v) and control water. Fish detected and avoided effluent at 50 and 100% (v/v), whereas no significant avoidance occurred at 12.5 and 25% (v/v). Although avoidance occurred at environmentally unrealistic effluent concentrations in terms of river dilution (i.e. > 15% v/v), these experiments implicated potential for the effluent outfall to act as a chemical barrier in the Tarawera River. Avoidance is rarely considered as an endpoint in wastewater discharge limits, and to date, no study I am aware of in NZ has assessed the avoidance response of fishes to pulp and mill effluent. Avoidance of aquatic discharges may be of high ecological significance in NZ freshwater systems, given that many of the native fish fauna exhibit diadromy. An understanding the factors that limit fish distribution is fundamental to their conservation (Adams et al., 2000, 2002).

To further investigate the potential influence of pulp and paper mill discharges on local common bully populations of the downstream Tarawera River, the aim of the final research chapter (4) was to conduct a wild fish health assessment to determine effects of long-term effluent exposure in situ. Fish may directly integrate the effects of environmental stressors through changes in condition, reproductive fitness, and health. Using a 'sentinel' species approach, adult common bully were sampled downstream of mill influence and compared to a previously verified reference population from the downstream Rangitaiki River (Chapter 2). A selection of biomarkers were measured across several level of

biological organisation, ranging from organism to biochemical responses, as an integrated measure of individual health. Male and female fish from the Tarawera River demonstrated 6- to 9-fold greater ethoxyresorufin-O-deethylase (EROD) activity compared to reference fish, indicating exposure to contaminants in this river. Tarawera females showed some minor variation in haematological variables including decreased mean cell volume (MCV), mean cell haemoglobin (MCH) and increased total white blood cell count (WBCC) suggestive of an immune response. Slightly greater ovarian follicular steroid production in Tarawera fish potentially indicates some form of endocrine alteration. However, this response may also be related to differences in reproductive synchrony and gonadal development between the two fish populations.

Collectively the research demonstrated the potential of pulp and paper mill effluent to influence the distribution and migratory patterns of common bully in a river system. These findings warrant further investigation into the avoidance response of native migratory fishes to anthropogenic discharges. Resident fish downstream of the mill influence in the Tarawera River showed indication of exposure and response to contaminants in the pulp mill effluent but no apparent decline in health or reproductive fitness was inferred comparable to the reference fish. These results can be used in future investigations by acting as a benchmark to which to assess ongoing changes or improvements in the mill effluent, and for further potential developments on the river system.

## References

- Adams, S.M. 2003. Establishing causality between environmental stressors and effects on aquatic ecosystems. *Human and Ecological Risk Assessment*, 9:17-35.
- Adams, S.B., Frissell, C.A. and Rieman, B.E. 2002. Changes in distribution of non-native brook trout in an Idaho drainage over two decades. *Transaction of the American Fisheries Society*, 131: 561–568.
- Adams, S.M., Greeley, M.S. 2000. Ecotoxicological indicators of water quality: using multi-response indicators to assess the health of aquatic ecosystems. *Water, Air, and Soil Pollution*, 123:103–115.
- Adams, S.M., Greeley, M.S., Ryon, M.G. 2000. Evaluating Effects of Contaminants on Fish Health at Multiple Levels of Biological Organization: Extrapolating from Lower to Higher Levels. *Human and Ecological Risk Assessment*, 6: 15 - 27
- Adams, S.M., Crumbly, W.D., Greenley Jr, M.S., Ryon, M.G. and Schilling, E.M. 1992. Relationships between physiological and fish population responses in a contaminated stream. *Environmental Toxicology and Chemistry*, 11: 1549–1557.
- Adams, S.M., Brown, A.M., Goede, R.W. 1993. A quantitative health assessment index for rapid evaluation of fish condition in the field. *Transactions of the American Fisheries Society*, 122: 63-73.
- Adams, S. M. 1990. Status and use of biological indicators for evaluating the effects of stress on fish. *American Fisheries Society Symposium*, 8: 1-8.
- Adams, S. M., McLean, R. B. 1985. Estimation of largemouth bass, *Micropterus salmoides* Lacépède, growth using the liver somatic index and physiological variables. *Journal of Fish Biology*, 26: 111-126.

- Ahnelt, H., Göschl, J., Dawson, M.N., Jacobs, D.K. 2004. Geographical variation in the cephalic lateral line canals of *Eucyclogobius newberryi* (Teleostei, Gobiidae) and its comparison with molecular phylogeography. *Folia Zoologica*, 53: 358 -398.
- Ali, M., Shreekrishnan, T.R. 2001. Aquatic toxicity from pulp mill effluents: a review. *Advances in Environmental Research*, 5: 175-196.
- Allibone, R.M., Wallis, G.P. 1993. Genetic variation and diadromy in some native New Zealand galaxiids (Teleostei: Galaxiidae). *Biological Journal of the Linnean Society*, 50: 19-33.
- Atland, A. 1998. Behavioural responses of brown trout, *Salmo trutta*, juveniles in concentration gradients of pH and Al – a laboratory study. *Environmental Biology of Fishes*, 53: 331-345.
- Axegård, P., Carey, J., Folke, J., Gleadow, P., Gullichsen, J., Pryke, D.C., Reeve, D.W., Swan, B., Uloth, V. 1997. In. Minimum-Impact Mills: Issues and Challenges. Environmental Conference, Minneapolis, MN. Tappi Press, Atlanta, GA, pp 559-541.
- Baker, C.F., Montgomery, J.C. 2001. Sensory deficits induced by cadmium in banded kokopu, *Galaxias fasciatus*, juveniles. *Environmental Biology of Fishes*, 62: 455-464.
- Barriga, J.P., Battini, M. A., Cussac, V. E. 2007. Annual dynamics variation of a landlocked *Galaxias maculatus* (Jenyns 1842) population in a Northern Patagonian river: occurrence of juvenile upstream migration. *Journal of Applied Ichthyology*, 23: 128-135.
- Barry, T.P., Santos, A.J.G., Furukawa, K., Aida, K., Hanyu, I. 1990. Steroid profiles during spawning in male common carp. *General and Comparative Endocrinology*, 80: 223.

Beitinger, T.L., Freeman, L. 1983. Behavioral avoidance and selection responses of fishes to chemicals. *Residue Reviews*, 90: 35–55.

Birtwell, I.K., Kruzynski, G.M. 1989. In-situ and laboratory studies on the behaviour and survival of Pacific Salmon (genus *Oncorhynchus*). *Hydrobiologia*, 188/189: 543-560.

Boubee, J. A. T., Dean, T. L., West, D. W., Barrier, R. F. G. 1997. Avoidance of suspended sediment by the juvenile migratory stage of six New Zealand native fish species. *New Zealand Journal of Marine and Freshwater Research*, 31: 61-69.

Bridges, C.M. 1997. Tadpole swimming performance and activity affected by acute exposure to sublethal levels of carbaryl. *Environmental Toxicology and Chemistry*, 16: 1935–1939.

Buckel, J.A., Sharack, B.L., Zdanowicz, V.S. 2004. Effect of diet on otolith composition in *Potatomus saltatrix*, an estuarine piscivore. *Journal of Fish Biology*, 64: 1469-1484.

Burstall, P.J. 1980. The introduction of freshwater fish into Rotorua lakes. Rotorua 1880-1980. In. Rotorua, New Zealand: Rotorua and district historical society. Eds. Stafford R, Steele JB., pp 115-121.

Cairns, J., Jr. 1981 Biological monitoring. Part IV. Future needs. *Water Research*, 15: 941-952.

Campana, S.E. 1999. Chemistry and composition of fish otoliths: pathways, mechanisms and applications. *Marine Ecology Progress Series*, 188: 263-297.

Cherry, D.S., Larrick, S.R., Giattina, J.D., Dickson, K.L., Cairns, J.Jr. 1979. Avoidance and toxicity responses of fish to intermittent chlorination. *Environment International*, 2: 85-90.

Chapman, A., Morgan, D.L., Beatty, S.J., Gill, H.S. 2006. Variation in Life History of Land-Locked Lacustrine and Riverine Populations of *Galaxias maculatus* (Jenyns 1842) in Western Australia. *Environmental Biology of Fishes*, 77: 21-37.

Chellappa, S., Huntingford, F.A., Strang, R.H.C., Thomson, R.Y. 1995. Condition factor and hepatosomatic index as estimates of energy status in male three-spined stickleback. *Journal of Fish Biology*, 47: 775-87.

Closs, G.P., Smith, M., Barry, B., Markwitz, A. 2003. Non-diadromous recruitment in coastal populations of common bully (*Gobiomorphus cotidianus*). *New Zealand Journal of Marine and Freshwater Research*, 37: 301-313.

Coombs, S., Janssen, J., Montgomery, J. C. 1992. Functional and evolutionary implications of peripheral diversity in lateral line systems. In. *The Evolutionary Biology of Hearing*. Eds. D. B. Webster, R. R. Fay and A. N. Popper. Springer-Verlag, New York, pp. 267-294.

Coombs, S., Janssen, J., Webb, J. F. 1988. Diversity of lateral line systems: evolutionary and functional considerations. In. *Sensory Biology of Aquatic Animals*. Eds J. Atema, R. R. Fay, A. N. Popper and W. N. Tavolga. Springer-Verlag, New York, pp. 553-595.

Dacie, J.V. and S.M. Lewis, 1991. *Practical haematology 7th (Ed.) ELBS with Churchill Livingstone, England*, pp: 37-85.

Dell, P., Power, F., Donaki, R., McIntosh, J., Park, S., Pang, L. 1996: Monitoring environmental effects and regulating pulp and paper discharges: Bay of Plenty, New Zealand. In: *Environmental Fate and Effects of Pulp and Paper Mill Effluents*. Eds. M.R. Servos, K. R. Munkittrick, J.H. Carey and G.J. Van Der Kraak. St. Lucie Press, Delray Beach, FL, pp 1982-1983

Dell'Omo, G., 2002. *Behavioural Ecotoxicology* - Published by Wiley and Sons, New York, pp 463.

DeLonay, A.J., Little, E.E., Lipton, J.J., Woodward, D.F., Hansen, J. 1996. Behavioral avoidance as evidence of injury of fishery resources: Applications to natural resource damage assessments. In: *Environmental Toxicology and Risk Assessment: Fourth Volume*, ASTM STP 1262, American Society for Testing and Materials. Eds. T.W. LaPoint, F.T. Price, E.E. Little. Philadelphia, pp. 268-280.

Dubé, M., Culp, J., MacLatchy, D., Gillis, G., Parker, R., Courtenay, S., Gilman, C. 2002. Utility of field-based artificial streams for assessing effects of pulp mill effluents on fish. *Journal of Aquatic Ecosystem Stress and Recovery*, 9: 85–102.

Dubé, M.G., McLatchy, D.L. 2000. Endocrine responses of *Fundulus heteroclitus* to effluent from a bleached-kraft mill before and after installation of reverse osmosis treatment of a waste stream. *Environmental Toxicology and Chemistry*, 19: 2788–2796.

Dunham, J.B., Rieman, B.E., Peterson, J.T. 2002. Patch-based models of species occurrence: lessons from salmonid fishes in streams. In: *Predicting Species Occurrences: Issues of Accuracy and Scale*. Eds. Scott, J.M., Heglund, P.J., Samson, F., Haufler, J., Morrison, M., Raphael, M., Wall, B. Island Press, Covelo, CA, pp. 327–334.

Ellis, R.J., van den Heuvel, M.R., Stuthridge, T.R., Ling, N., Dietrich, D.R. 2004. Lack of Estrogenic and Endocrine Disrupting Effects in Juvenile Rainbow Trout Exposed to a New Zealand Pulp and Paper Mill Effluent. In: *Pulp and Paper Mill Effluents Environmental Fate and Effects* Eds. Borton, D.L., Hall, T.J., Fisher, R.P., Thomas, J.F. DESTech Publications, Inc., Lancaster, PA.

Ellis, R.J., van den Heuvel, M.R., Bandelj, E., Smith, M.A., McCarthy, L.H., Stuthridge, T.R., Dietrich, D.R. 2003. In vivo and in vitro assessment of the androgenic potential of a pulp and paper mill effluent. *Environmental Toxicology and Chemistry*, 22: 1448–1456.

Ellis, R.J., van den Heuvel, M.R., Stuthridge, T.R., McCarthy, L.H., Dietrich, D.R. 2000. Masculinisation of adult female mosquitofish (*Gambusia affinis affinis*) exposed to pulp and paper mill wastewaters. In. Proceeding of the 27<sup>th</sup> Annual Aquatic Toxicity Workshop. St Johns, Newfoundland, Canada, p.116.

Elsdon, T.S., and Gillanders, B.M. 2005. Alternative life history patterns of estuarine fish: barium in otoliths elucidates freshwater residency. *Canadian Journal of Fisheries and Aquatic Sciences*, 62: 1143-1152.

Elsdon, T.S., and Gillanders, B.M. 2005. Consistency of patterns between laboratory experiments and field collected fish in otolith chemistry: an example and applications for salinity reconstructions. *Marine & Freshwater Research*. 55: 609-617.

Elsdon, T.S., Gillanders, B.M. 2002. Interactive effects of temperature and salinity on otolith chemistry: challenges for determining environmental histories of fish. *Canadian Journal of Fisheries and Aquatic Sciences*, 59: 1796-1808.

Fitzgerald, J.M. 1996. Carbon-13 and Oxygen-18 Geochemistry of the Waikato River. MSc. Department of Chemistry, University of Waikato. pp128.

Forlin, L., Andersson, T., Balk, L., Larsson, A. 1995. Biochemical and physiological effects in fish exposed to bleached kraft mill effluents. *Ecotoxicology and Environmental Safety*, 30: 164-170.

Foster, AR, Houlihan, DF, Hall, SJ. 1993. Effects of nutritional regime on correlates of growth rate in juvenile Atlantic cod (*Gadhus morhua*): comparisons of morphological and biochemical measurements. *Canadian Journal of Fisheries and Aquatic Sciences*, 50:502-12.

Fuiman, L.A., Higgs, D.M., Poling, K.R. 2004. Changing structure and function of the ear and lateral line system of fishes during development. *American Fisheries Society Symposium*, 40:117-144

- Gagnon, M.M., Dodson, J.J., Hodson, P.V. 1994. Ability of BKME (bleached kraft mill effluent) exposed white suckers (*Catostomus commersoni*) to synthesize steroid hormones. *Comparative Biochemistry and Physiology*, 107C: 265-273.
- Galloway, B.J., Munkittrick, K.R. 2006. Influence of seasonal changes in relative liver size, condition, relative gonad size and variation in ovarian development in multiple spawning fish species used in environmental monitoring programmes. *Journal of Fish Biology*, 69: 1788-1806.
- Giattina, J.D., Garton, R.R. 1983. A review of the preference-avoidance responses of fishes to aquatic contaminants. *Residue Reviews*, 87:44–90
- Gibbons, W.N., Munkittrick, K.R., McMaster, M.E., Taylor, W.D. 1998. Monitoring aquatic environments receiving industrial effluents using small fish species 2: Comparison between responses of trout-perch (*Percopsis omiscomaycus*) and white sucker (*Catostomus commersoni*) downstream of a pulp mill. *Society of Environmental Toxicology and Chemistry*, 17: 2238-2245
- Gibbons, W.N., Munkittrick, K.R. 1994. A sentinel monitoring framework for identifying fish population responses to industrial discharges. *Journal of Aquatic Ecosystem Health*, 3: 227-237
- Gillanders, B.M. 2005. Using elemental chemistry of fish otoliths to determine connectivity between estuarine and coastal habitats. *Estuarine, Coastal and Shelf Science*, 64: 47–57
- Gray, J.E., Hines, M.E., Higuera, P.L., Adatto, I., Lasorsa, B.K. 2004. Mercury speciation and microbial transformations in mine wastes, stream sediments, and surface waters at the Almadén Mining District, Spain. *Environmental Science and Technology*, 38: 4285–4292.
- Gray, R.H. 1983. Behavioural response of fish to altered water quality: A review of selected examples with emphasis on salmonoids. *Environmental Impact Assessment Review*, 4: 84-96.

Griffiths, D, Kirkwood, RC. 1995. Seasonal variation in growth, mortality and fat stores of roach and perch in Lough Neagh, Northern Ireland. *Journal of Fish Biology*, 47: 537-54.

Hansen, J.A., Woodward, D.F., Little, E.E., Delonay, A.J., Bergman, H.L. 1999. Behavioural avoidance: a possible mechanism for explaining abundance and distribution of trout species in a metals impacted river. *Environmental Toxicology and Chemistry*, 18: 313-317.

Hartwell, S.I., Jin, J.H., Cherry, D.S., Cairns, J., Jr. 1987. Toxicity versus avoidance response of gold shiner, *Notemigonus crysoleucas*, to five metals. *Journal of Fish Biology*, 35: 447-457.

Hayes, J. W., Leathwick, J. R., Hanchet, S. M. 1989. Fish distribution patterns and their association with environmental factors in the Mokau River catchment, New Zealand. *New Zealand Journal of Marine and Freshwater Research*, 23: 171-180.

Healey, J. 1962. Geology of the Rotorua district. *Proceedings of the NZ Ecological Society*, 10: 54-58.

Hewitt, M.L., Smythe, S.A., Dubé, M.G., Gilman, C.I. and MacLatchy, D.L., 2002. Isolation of compounds from bleached kraft mill recovery condensates associated with reduced levels of circulating testosterone in mummichog (*Fundulus heteroclitus*). *Environmental Toxicology and Chemistry*, 21: 1359–1367.

Hicks, B.J., Wipfli, M.S., Lang, D.W., Lang, M.E. 2005. Marine-derived nitrogen and carbon in freshwater-riparian food webs of the Copper River Delta, southcentral Alaska. *Oecologia*, 144: 558–569.

Hogue, C.C. 1999. Avoidance responses of rainbow trout and Utah chub to rotenone. *North American Journal of Fisheries Management*, 19: 171-179.

Humphries, P. 1990. Morphological variation in diadromous and landlocked populations of the spotted galaxias, *Galaxias truttaceus*, in Tasmania, south-eastern Australia. *Environmental Biology of Fishes*, 27: 97-105.

Humphries, P. 1989. Variation in the life history of diadromous and landlocked populations of the spotted galaxias, *Galaxias truttaceus* Valenciennes, in Tasmania. *Australian journal of marine and freshwater research*, 40: 501-518.

Janz, D.M., McMaster, M.E., Weber, L.P., Munkittrick, K.R., Van Der Kraak, G. 2001. Recovery of ovary size, follicle cell apoptosis and HSP70 expression in fish exposed to bleached pulp mill effluent. *Canadian Journal of Fisheries and Aquatic Sciences*, 58: 620-625.

Janz, D.M., McMaster, M.E., Munkittrick, K.R., Van Der Kraak, G. 1997. Elevated ovarian follicular apoptosis and heat shock protein-70 expression in white sucker exposed to bleached kraft pulp mill effluent. *Toxicology and Applied Pharmacology*, 147: 391-389.

Jellyman, D. J. 1977. Summer upstream migration of juvenile freshwater eels in New Zealand. *New Zealand Journal of Marine and Freshwater Research*, 11: 61-71.

Jokinen, E.I., Aaltonen, T.M., Valtonen, E.T. 1995. Subchronic effects of pulp and paper mill effluents on the immunoglobulin synthesis of Roach, *Rutilus rutilus*. *Ecotoxicology and Environmental Safety*, 32: 219-225.

Joy, M. K., Death, R. G. 2000. Development and application of a predictive model of riverine fish community assemblages in the Taranaki region of the North Island, New Zealand. *New Zealand Journal of Marine and Freshwater Research*, 34: 243- 254.

- Joy, M. K., Henderson, I. M., Death, R. G. 2000: Diadromy and longitudinal patterns of upstream penetration of freshwater fish in Taranaki, New Zealand. *New Zealand Journal of Marine and Freshwater Research*, 34: 531–543.
- Judd, M.C., Stuthridge, T.R., McFarlane, P.N., Anderson, S.M., Bergman, I. 1996. Bleached kraft pulp mill sourced organic chemicals in sediments from a New Zealand river. Part 2. Tarawera River. *Chemosphere*, 33: 2209-2220.
- Karels, A. E., Soimasuo, M., Laappivaara, J., Leppänen, H., Aaltonen, T., Mellanen, P. and Oikari, A. O. J. 1998. Effects of ECF-bleached Kraft mill effluent on reproductive steroids and liver MFO activity in populations of perch and roach. *Ecotoxicology*, 7: 123.
- Kelso, J.R.M. 1977. Density, distribution, and movement of Nipigon Bay fishes in relation to pulp and paper mill effluent. *Journal of the Fisheries Research Board of Canada*, 34: 879-885.
- Kovacs, T., Martel, P., Ricci, M., Michaud, J., Voss, R. 2005. Further insights into the potential of pulp and paper mill effluents to affect fish reproduction. *Journal of Toxicology and Environmental Health, Part A*, 68: 1621-1641.
- Kovacs, T. G., Megraw S. R., Martel, P. H. 1997. Perspectives on Canadian field studies examining the potential of pulp and paper mill effluent to affect fish reproduction. *J. Toxicol. Environ. Health* 51: 305–352.
- Kroon, F.J. 2005. Behavioural avoidance of acidified water by juveniles of four commercial fish and prawn species with migratory life stages. *Marine Ecology-Progress Series*, 285: 193-204.
- Landman, M.J., Taylor, S. van den Heuvel, M.R. In Press. Carotenoid depletion and ovarian dysfunction in common bully exposed to a New Zealand pulp mill effluent. *Aquatic Toxicology* (2007), doi:10.1016/j.aquatox.2008.02.015

Landman, M., Brijs, J., Glover, C., Ling, N. 2007. Lake Okareka and Tikitapu Fish Health Monitoring 2007. Scion Report prepared for Environment Bay of Plenty. 30 October 2007

Landman, M.J., Ling, N. 2006. Lake Okareka and Tikitapu Fish Health Monitoring 2006. Scion Report prepared for Environment Bay of Plenty. 13 December 2006

Landman, M.J., van den Heuvel, M.R., Finley, M., Bannon, H.J., Ling, N. 2006 Combined effects of pulp and paper effluent, dehydroabietic acid, and hypoxia on swimming performance, metabolism, and hematology of rainbow trout. *Ecotoxicology and Environmental Safety*, 65: 314-322.

Landman, M.J., Van Den Heuvel, M.R., Ling, N. 2005. Relative sensitivities of common freshwater fish and invertebrates to acute hypoxia. *New Zealand Journal of Marine and Freshwater Research*, 39:1061-1067.

Landman, M.J. 2004. Elimination of Pulp and Paper Effluent-Hypoxia Interactions in Fish. A thesis submitted in partial fulfilment of the requirements for the degree of Doctor of Philosophy at The University of Waikato by Michael Jon Landman.

Landman, M.J., van den Heuvel, M.R., Ling, N. 2004. Pulp and paper effluent-hypoxia interactions in fish. In: Pulp and paper mill effluent environmental fate and effects. Eds. Borton DL, Hall TJ, Fisher RP, Thomas JF. Lancaster, PA, United States, DEStech Publications, pp 506–516.

Larsson, J., Förlin, L. 2002. Male-biased sex ratios of fish embryos near a pulp mill: temporary recovery after a short-term shutdown. *Environmental Health Perspectives*, 110: 739–742.

Lewis, F. G., Livingston, R. J. 1977. Avoidance of bleached kraft pulp mill effluent by pinfish (*Lagodon rhomboides*) and gulf killifish (*Fundulus grandis*). *Journal of the Fisheries Research Board of Canada*, 34: 568-570.

Leppänen, H., Oikari, A. 1999. Occurrence of retene and resin acids in sediments and fish bile from a lake receiving pulp and paper mill effluents. *Environmental Toxicology and Chemistry*, 18: 1498-1505.

Leusch, F.D.L., MacLatchy, D.L. 2003. In vivo implants of  $\beta$ -sitosterol cause reductions of reactive cholesterol pools in mitochondria isolated from gonads of male goldfish (*Carassius auratus*). *General and Comparative Endocrinology*, 134: 255-263

Lindesjoo, E., Adolfsson-Erici, M., Ericson, G., Forlin, L. 2002. Biomarker responses and resin acids in fish chronically exposed to effluents from a total chlorine-free pulp mill during regular production. *Ecotoxicology and Environmental Safety*, 53: 238-247.

Little, E.E., Fairchild, J.J., DeLonay, A.J. 1993. Behavioural methods for assessing impacts of contaminants on early life stage fishes. *Water Quality and the Early Life Stages of Fishes, American Fisheries Society Symposium*, 14: 67-76.

Little, E.E., Flerov, B.A., Ruzhinskaya, N.N. 1985. Behavioural approaches in aquatic toxicity investigations: a review. In: Toxic substances in the aquatic environment: an international aspect. Eds. P.M. Merhle, Jr., R.H. Gray and R.L. Kendall. American Fisheries Society, Bethesda, Maryland.

Martel, P.H., Kovacs, T.G., Voss, R.H. 1996. Effluents from Canadian pulp and paper mills: A recent investigation of their potential to induce mixed function oxygenase activity in fish. In: Environmental fate and effects of pulp and paper mill effluents. Eds. Servos ME, Munkittrick KR, Carey JH, Van Der Kraak GJ. St. Lucie Press, FL, pp 401-412

McCarthy, J.F., Shugart, L.R. 1990. Biological Markers of Environmental contamination. In. Biomarkers of Environmental Contamination. Lewis Publishers, Boca Raton, Florida, pp 3-14.

- McDowall, R.M., Stevens, M.I. 2007. Taxonomic status of the Tarndale bully *Gobiomorphus alpinus* (Teleostei: Eleotridae), revisited—again. *Journal of the Royal Society of New Zealand*, 37: 15–29.
- McDowall, R.M. 2003. Variation in Vertebral Number in Galaxiid Fishes (Teleostei: Galaxiidae): A Legacy of Life History, Latitude and Length. *Environmental Biology of Fishes*, 66: 361-381.
- McDowall, R.M. 2003. Variation in Vertebral Number in Galaxiid Fishes, How Fishes Swim and a Possible Reason for Pleomerism. *Reviews in Fish Biology and Fisheries*, 13: 247-263.
- McDowall, R.M. 2001. Diadromy, diversity and divergence: implications for speciation processes in fishes. *Fish and Fisheries*, 2: 278 - 285.
- McDowall, R. M., Taylor, M. J. 2000. Environmental indicators of habitat quality in a migratory freshwater fish fauna. *Environmental Management*, 25: 357-374.
- McDowall, R.M. 1998. Phylogenetic relationships and ecomorphological divergence in sympatric and allopatric species of *Paragalaxias* (Teleostei: Galaxiidae) in high elevation Tasmanian Lakes. *Environmental Biology of Fishes*, 53: 235-257.
- McDowall, R.M. 1997. Is there such a thing as amphidromy? *Micronesica*, 30: 3-14.
- McDowall, R.M. 1994. The Tarndale bully, *Gobiomorphus alpinus* Stokell (Pisces: Eleotridae) revisited and redescribed. *Journal of the Royal Society of New Zealand*, 24: 117-124.
- McDowall, R. M. 1993. Implications of diadromy for the structuring and modelling of riverine fish communities in New Zealand. *New Zealand Journal of Marine and Freshwater Research*, 27: 453–462.

McDowall, R.M. 1992. Diadromy: origins and definitions of terminology. *Copeia*, 1992: 248-251.

McDowall, R. M. 1990. New Zealand Freshwater Fishes: A Natural History and Guide. Heinemann Reed, Auckland.

McDowall, R.M. 1988. Diadromy in Fishes: Migrations Between Freshwater and Marine environments. Croomhelm, London.

McDowall, R. M. 1987. Evolution and the importance of diadromy; The occurrence and distribution of diadromy among fishes. *American Fisheries Society Symposium*, 1:1-13.

McDowall, R.M., Frankenberg, R.S. 1981. The galaxiid fishes of Australia. *Records of the Australian Museum*, 33: 443–605.

McDowall, R. M., Eldon, G. A. 1980. The ecology of whitebait migrations (Galaxiidae: *Galaxias* spp.). New Zealand Ministry of Agriculture and Fisheries, *Fisheries Research Bulletin*, 20: 1-171.

McDowall, R. M. 1972a. The taxonomy of estuarine and brackish-lake *Retropinna* from New Zealand (Galaxoidei: Retropinnidei). *Journal of the Royal Society of New Zealand*, 2: 501- 531.

McDowall, R.M. 1972b. The species problem in freshwater fishes and the taxonomy of diadromous and lacustrine populations of *Galaxias maculatus* (Jenyns). *Journal of the Royal Society of New Zealand*, 2: 325-367.

McDowall, R.M. 1979. Fishes of the family Retropinnidae (Pisces: Salmoniformes)—a taxonomic revision and synopsis. *Journal of the Royal Society of New Zealand*, 9: 85-121.

McGreer, E.R., Vigers G.A. 1983. Development and validation of an in situ fish preference-avoidance technique for environmental monitoring of pulp mill effluents. In. Aquatic Toxicology and Hazard Assessment: 6<sup>th</sup> Symposium, ASTM Sm 802. Eds. W.E. Bishop, R.D. Cardwell & B.B. Heidolph, American Society for Testing and Materials, Philadelphia, pp 519-529.

McMaster, M.E., van der Kraak, G.J., Munkittrick, K.R. 1996. An epidemiological evaluation of the biochemical basis for steroid hormonal depressions in fish exposed to industrial wastes. *The Journal of Great Lakes Research*, 22: 153–171.

McMaster, M. E., K.R. Munkittrick, G.J. van der Kraak, P.A. Flett, M.R. Servos. 1996. Detection of steroid hormone disruptions associated with pulp mill effluent using artificial exposures of goldfish. In. M.R. Servos, K.R. Munkittrick, J.H. Carey, G.J. van der Kraak (Eds.), Environmental Fate and Effects of Pulp and Paper Mill Effluents, first ed., St. Lucie Press, DelRay Beach, FL, pp. 425–437.

McMaster, M. E., Munkittrick, K. R., Jardine, J. J., Robinson, R. D., Van Der Kraak, G. J. 1995. Protocol for measuring *in vitro* steroid production by fish gonadal tissue. *Canadian Technical Report of Fisheries and Aquatic Sciences*, 1961: 1-78.

McMaster, M.E., Munkittrick, K.R., Van Der Kraak, G.J., Flett, P.A., Servos, M.R. 1995. Detection of steroid hormone disruptions associated with pulp mill effluent using artificial exposures to goldfish. In: Servos, M.R., Munkittrick, K.R., Carey, J.H. and Van Der Kraak, G.J., Editors, 1995. *Environmental Fate and Effects of Pulp and Paper Mill Effluents*, St Lucie Press, Boca Raton, FL.

McMaster, M.E., Munkittrick, K.R., Luxon, P.L., Van Der Kraak, G. 1994. Impact of low-level sampling stress on interpretation of physiological responses of white sucker exposed to effluent from a bleached kraft pulp mill. *Ecotoxicology and Environmental Safety*, 27: 251-264.

McMaster, M.E., Munkittrick, K.R., Van Der Kraak, G.J. Protocol for measuring circulating levels of gonadal sex steroids in fish. *Canadian Technical Report of Fisheries and Aquatic Sciences*, 1836: 1–29.

Michel, C., Hicks, B.J., Stölting, K.N., Clarke, A.C., Stevens, M.I., Tana, R., Meyer, A., van den Heuvel, M.R. 2008. Distinct migratory and non-migratory ecotypes of an endemic New Zealand eleotrid (*Gobiomorphus cotidianus*) - implications for incipient speciation in island freshwater fish species. *BMC Evolutionary Biology*, 8: 49.

Modgans, J. 2005. Adaptations of the fish lateral line for the analysis of hydrodynamic stimuli. In. *Marine Ecology Progress Series: Sensory biology: linking the internal and external ecologies of marine organisms*. Eds. Weissburg MJ, Browman HI, 287: 289-292.

Morales-Nin, B., Swan, S. C., Gordon, J. D. M., Palmer, M., Geffen, A. J., Shimmiel, T., and Sawyer, T. 2005. Age-related trends in otolith chemistry of *Merluccius merluccius* from the north-eastern Atlantic Ocean and the western Mediterranean Sea. *Marine and Freshwater Research*, 56: 599-607.

Munkittrick, K.R., McMaster, M.E., McCarthy, L.H., Servos, M.R., van der Kraak, G.J. 1998. An overview of recent studies on the potential of pulp-mill effluents to alter reproductive parameters in fish. *Journal of Toxicology and Environmental Health Critical Review, Part B*, 1: 347–371.

Munkittrick, K.R., Servos, M.R., Carey, J.H., Van Der Kraak, G.J. 1997. Environmental impacts of pulp and paper wastewater: Evidence for a reduction in environmental effects at North American pulp mills since 1992. *Water Science and Technology*, 35: 329–338.

Munkittrick, K.R., Van Der Kraak, G.J., McMaster, M.E., Portt, C.B., van den Heuvel, M.R. 1994. Survey of receiving-water environmental impacts associated with discharges from pulp mills 2: Gonad size, liver size, hepatic EROD activity

and plasma sex steroid levels in White. *Environmental Toxicology and Chemistry*, 13: 1089-1101.

Munkittrick, K.R., Van Der Kraak, G.J., McMaster, M.E. and Portt, C.B., 1992. Reproductive dysfunction and MFO activity in three species of fish exposed to bleached kraft mill effluent at Jackfish Bay, Lake Superior. *Water Pollution Research Journal of Canada*, 27: 439-446.

Myllyvirta T.P., Vuorinen, P.K. 1989. Avoidance of bleached kraft mill effluent by pre-exposed *Coregonus albula* L. *Water Research*, 23: 1219-1227.

Nespolo, R. F., Rosenmann, M. 2002. Intraspecific allometry of haematological parameters in *Basilichthys australis*. *Journal of Fish Biology*, 60: 1358-1362

Northcote, T. G., Ward, F. J. 1985. Lake resident and migratory smelt *Retropinna retropinna* (Richardson), of the lower Waikato River system, New Zealand. *Journal of fish biology*, 27: 113-129.

Orrego, R., Burgos, A., Moraga-Cid, G., Inzunza, B., Gonzalez, M., et al. 2006. Effect of Pulp and Paper Mill Discharges on Caged Rainbow Trout (*Oncorhynchus Mykiss*): Biomarker Responses along pollution gradient in the Biobio river, Chile. *Environmental Toxicology and Chemistry*, 25: 2280-2287.

Ovenden, J.R., White, R.W.G. 1990. Mitochondrial and allozyme genetics of incipient speciation in a landlocked population of *Galaxias truttaceus* (Pisces: Galaxiidae). *Genetics*, 124: 701-716.

Owens, J.W. 1991. The hazard assessment of pulp and paper effluents in the aquatic environment: a review. *Environmental Toxicology and Chemistry*, 10: 1511-1540.

Parrott, J.L., McMaster, M.E., Hewitt, M.L. 2006. A decade of research on the environmental impacts of pulp and paper mill effluents in Canada: Development

and application of bioassays. *Journal of Toxicology and Environmental Health*, Part B, 9: 297-317.

Parrott, J.L., C.S. Wood, P. Boutot and S. Dunn 2004. Changes in growth, secondary sex characteristics, and reproduction of fathead minnows exposed for a life cycle to bleached sulfite mill effluent. *Journal of Toxicology and Environmental Health, Part A*, 67: 1755–1764.

Park, S.G. 2001. Tarawera Fish Survey. *Rep. Environmental Report 01/02*, Environment Bay of Plenty, Whakatane, New Zealand.

Park, S.G., Wilding, T. 1998. Fish health in the Tarawera and Rangitaiki Rivers. *Rep. Environmental Report 98/19*, Environment Bay of Plenty, Whakatane, New Zealand.

Pokhrel, D., Viraraghavan, T. 2004. Treatment of pulp and paper mill wastewater – a review. *Science of the Total Environment*, 333: 37-58.

Rabeni, C. F., Smale, M. A. 1995. Effects of siltation on stream fishes and the potential mitigating role of the buffering riparian zone. *Hydrobiologia*, 303: 211-219.

Radtke, R. L., Kinzie III, R. A. 1996. Evidence of a marine larval stage in endemic Hawaiian stream gobies from isolated high-elevation locations. *Transactions of the American Fisheries Society*, 125: 613-621.

Radtke, R. L., Shafer, D. J. 1992. Environmental sensitivity of fish otolith microchemistry. *Australian Journal of Marine and Freshwater Research*, 43: 935-951.

Rand, G.M. 1985. Behavior. In, *Fundamentals of Aquatic Toxicology: Methods and Applications*. Rand, G.M., Petrocelli, S. R. (eds.). Hemisphere Publishing, New York, pp 221-256.

Redding, J.M. Patino, R. 1993. Reproductive physiology. In. *The Physiology of Fishes*. Editor, Evans, DH. Boca Raton (FL): CRC Press, pp 503-544.

Richardson, J., Williams, E.K., Hickey, C.W. 2001. Avoidance behaviour of freshwater fish and shrimp exposed to ammonia and low dissolved oxygen separately and in combination. *New Zealand Journal of Marine and Freshwater Research*, 35: 625-633.

Richardson, J. 1997. Acute ammonia toxicity for eight New Zealand indigenous freshwater species. *New Zealand Journal of Marine and Freshwater Research*, 31: 185-190.

Rickwood, C.J., Dubé, M.G., Hewitt, L.M., Parrott, J.L., MacLatchy, D.L. 2006. Use of paired fathead minnow (*Pimephales promelas*) reproductive test. Part I: Assessing biological effects of final bleached kraft pulp mill effluent using a mobile bioassay trailer system, *Environmental Toxicology and Chemistry*, 25: 191–201.

Rowe, D. K., and T. Deans. 1996. Effects of suspended solids on the feeding ability of five native fish species. *NIWA Science and Technology Series*, 43: 1-25.

Rowe, D.K., Chisnall, B.L. 1996. Size-related differences in diel feeding activity, prey selection and nocturnal migration strategy for the planktonic larvae of *Gobiomorphus cotidianus* in Lake Rotoiti (NI) New Zealand. *Archives Hydrobiologia*, 135: 485-497.

Rutherford, J.C. 1997. Effects of pulp-mill wastes on dissolved oxygen in the Tarawera River. In. Conference preprints of the 3<sup>rd</sup> international conference on environmental fate and effects of pulp and paper mill effluents. Rotorua, New Zealand, p.250.

Saglio, P., Olsén, K.H., and Bretaud, S. 2001. Behavioural and olfactory responses to prochloraz, bentazone, and nicosulfuron-contaminated flows in goldfish. *Archives of Environmental Contamination and Toxicology*, 41: 192-200.

Saunders, R.L., and Sprague, J.B. 1967. Effect of copper-zinc mining pollution on a spawning migration of Atlantic salmon. *Water Research*, 1: 419-432.

Secor, D. H., Rooker, J. R. 2000. Is otolith strontium a useful scaler of life cycles in estuarine fishes? *Fisheries Research*, 46: 359–371.

Scherer, E., McNicol, R.E. 1998. Preference-avoidance responses of lake whitefish (*Coregonus clupeaformis*) to competing gradients of light and copper, lead and zinc. *Water Research*, 32: 924-929.

Scott, S.G., Pankhurst, N.W. 1992. Interannual variation in the reproductive cycle of the New Zealand snapper *Pagrus auratus* (Bloch and Schneider) (Sparidae). *Journal of Fish Biology*, 41: 685-96.

Schmitt, C.J., and Dethloff, G.M. editors. 2000. Biomonitoring of Environmental Status and Trends (BEST) Program: selected methods for monitoring chemical contaminants and their effects in aquatic systems. U.S. Geological Survey, Biological Resources Division, Columbia, (MO): Information and Technology Report USGS/BRD-2000--0005. pp 81.

Scherer, E., McNicol, R.E. 1998. Preference-avoidance responses of lake whitefish (*Coregonus clupeaformis*) to competing gradients of light and copper, lead and zinc. *Water Research*, 32: 924-929.

Servos, M.R., Munkittrick, K.R., Carey, J.H., Van Der Kraak, G.J. (eds.). 1996. Environmental fate and effects of pulp and paper mill effluents. St. Lucie Press, Delray, Florida.

Shimp, R.J., Owens, J.W., 1993. Pulp and paper technologies and improvements in environmental emissions to aquatic environments. *Toxicological and Environmental Chemistry*, 40: 213-233.

Smith, P.J., McVeagh, S.M., Allibone, R. 2003. The Tarndale bully revisited with molecular markers: an ecophenotype of the common bully *Gobiomorphus*

*cotidianus* (Pisces: Gobiidae). *Journal of the Royal Society of New Zealand*, 33: 663-673.

Sprague, J.B., Drury, D.E. 1969. Avoidance reactions of salmonid fish to representative pollutants. In. *Advances in Water Pollution Research, Proc. Forth Internat. Conf.*, S.H. Jenkins (ed.), Prague, Oxford: Pergamon Press, Vol. 1, p.169-179.

Sprague, J.B. 1968. Avoidance reactions of rainbow trout to zinc sulphate solutions. *Water Research*, 2: 367-372.

Sprague, J.B., Elson, P.F., Saunders, R.L. 1965. Sublethal copper-zinc pollution in a salmon river-a field and laboratory study. *International Journal of Air and Water Pollution*, 8: 531-543.

Stephens, R.T.T. 1982. Reproduction, growth and mortality of the common bully, *Gobiomorphus cotidianus* McDowall, in a eutrophic New Zealand lake. *Journal of Fish Biology*, 20: 259-270.

Svecevičius, G. 2007. The use of fish avoidance response in identifying sublethal toxicity of heavy metals and their mixtures. *Acta Zoologica Lituanica*, 17: 1392-1657.

Swanson, S. 1996. Field and laboratory responses of whole organisms associated with pulp mills. In. *Environmental Fate and Effects of Pulp and Paper Mill Effluents*. Eds. M.R. Servos, K.R. Munkittrick, J.H. Carey and G.J. Van Der Kraak. DelRay Beach, FL: St. Lucie Press, pp. 581–587.

Swearer, S.E. 2000. Self-recruitment in coral reef fish populations. PhD thesis, University of California, Santa Barbara, CA.

Taylor, J.R., Park, S.G. 2001: Natural environment regional monitoring network: Bay of Plenty rivers' water quality (1989-2000) *Rep. Environmental Report 10/12*, Environment Bay of Plenty, Whakatane, New Zealand.

Thompson, G., Swain, J., Kay, M., Froster, C.F. 2001. The treatment of pulp and paper mill effluent: a review. *Bioresarch Technology*, 77: 275-286.

Tavares-Dias, M. 2006. A morphological and cytochemical study of erythrocytes, thrombocytes and leukocytes in four freshwater teleosts. *Journal of Fish Biology*, 68: 1822-183.

Tavendale, M. H., McFarlane, P. N., Mackie, K. L., Wilkins, A. L., Langdon, A. G. 1997. The fate of resin acids-1. The biotransformation and degradation of deuterium labelled dehydroabietic acid in anaerobic sediments. *Chemosphere*, 35: 2137-2151.

Tavendale, M. H., McFarlane, P. N., Mackie, K. L., Wilkins, A. L., Langdon, A. G. 1997. The fate of resin acids-2. The fate of resin acids and resin acid derived neutral compounds in anaerobic sediments. *Chemosphere*, 35: 2153-2166.

Tavendale, M.H., Wilkins, A.L., Langdon, A.G., Mackie, K.L., Stuthridge, T.R., McFarlane, P.N. 1995. Analytical methodology for the determination of freely available bleached kraft mill effluent-derived organic constituents in recipient sediments. *Environmental Science and Technology*, 29:1407-1414.

Tremblay, L.A., Moore, S., van den Heuvel, M.R., West, D.W. 2005. Methods for determining the effects of pollution on fishes. Lincoln, New Zealand: Landcare Research. LCR Report No. LC0405/077.

Tremblay, L., Van Der Kraak, G. 1999. Comparison between the effects of the phytosterol  $\beta$ -sitosterol and pulp and paper mill effluents on sexually immature rainbow trout. *Environmental Toxicology and Chemistry*, 18, 329–336.

van den Heuvel, M.R., Landman, M.J., West, D.W., Finley, M. 2008. The effects of reduced energy intake in combination with pulp and paper effluent exposure on the physiology of rainbow trout. *Ecotoxicology and Environmental Safety*, 69: 187-198.

van den Heuvel, M.R., Michel, C., Stevens, M.I., Clarke, A.C., Stölting, K.N., Hicks, B.J., Tremblay, L.A. 2007. Monitoring the effects of pulp and paper effluent is restricted in genetically distinct populations of common bully (*Gobiomorphus cotidianus*). *Environmental Science & Technology*, 41: 2602-2608.

van den Heuvel, M.R., Landman, M.J., Tremblay, L. A. 2006. Responses of shortfin eel (*Anguilla australis*) to pulp and paper effluent using in situ exposures. *Journal of Toxicology and Environmental Health, Part A*, 69: 1763-1779.

van den Heuvel M.R., Bandelj E., Donald R., Ellis R.J., Smith M.A., Finley M., McCarthy L.H., Stuthridge, T.R. 2004. Review of reproductive-endocrine effects of a New Zealand pulp and paper mill effluent. In. Proceedings of the 5th International Conference on the Fate and Effects of Pulp and Paper Mill Effluents. DEStech Publications, pp 56-66.

van den Heuvel, M. R., Ellis, R. J. 2002. Timing of exposure to a pulp and paper effluent influences the manifestation of reproductive effects in rainbow trout. *Environmental Toxicology and Chemistry*, 21: 2338- 2347.

van den Heuvel, M.R., Ellis, R.J., Tremblay, L.A., Stuthridge, T.R. 2002. Exposure of reproductively maturing rainbow trout to a New Zealand pulp and paper mill effluent. *Ecotoxicology and Environmental Safety*, 51: 65-75.

Ward, F.J., Northcote, T.G., Boubée, J.A.T. 2005. The New Zealand common smelt: biology and ecology. *Journal of Fish Biology*, 66: 1-32.

Wayland, M., Hobson, K.A. 2001. Stable carbon, nitrogen, and sulfur isotope ratios in riparian food webs on rivers receiving sewage and pulp-mill effluents. *Canadian Journal of Zoology*, 79: 5-15.

West, D.W. 2006. Responses of wild freshwater fish to anthropogenic stressors in the Waikato River of New Zealand. A thesis submitted in partial fulfilment of the

requirements for the degree of Doctor of Philosophy at The University of Waikato  
by David W. West

West, D.W., Ling, N., Hicks, B.J., Tremblay, L.A., Kim, N.D., et al. 2006.  
Cumulative impacts assessment along a large river, using brown bullhead catfish  
(*Ameiurus Nebulosus*) Populations. *Environmental Toxicology and Chemistry*, 25:  
1868–1880.

Woodward, D.F., Goldstein, J.N., Farag, A.M., Brumbaugh, W.G. 1997. Cutthroat  
trout avoidance of metals and conditions characteristic of a mining waste site:  
Coeur d'Alene River, Idaho. *Transactions of American Fisheries Society*, 126:  
699-706.

World Bank. 1998. Pollution prevention and abatement handbook, 1998: Toward  
cleaner production in collaboration with the United Nations Environment  
Programme and the United Nations Industrial Development Organization. The  
International Bank for Reconstruction and Development/THE WORLD BANK  
*Washington, D.C.* pp 395-400.

Young, K. 2002. Survival of juvenile inanga and koaro in the lower Tarawera  
River (summer 1998/99). *Rep. Science internal series 49*, Department of  
Conservation, Wellington, New Zealand.

Young, K., Griffith, R. 1999. Diversity and distribution of freshwater fish in the  
tributaries of the Tarawera River. Bay of Plenty Freshwater Fish Report 99/3.  
Unpublished report, Bay of Plenty Conservancy, Department of Conservation,  
Rotorua.

Zacherl, D.C., Paradis, G., Lea, D.W. 2003. Barium and strontium uptake into  
larval protoconchs and statoliths of the marine neogastropod *Kelletia kelletii*.  
*Geochim Cosmochim Acta*, 67:4091–4099

Zender, J.A., Stuthridge, T.R., Langdon, A.G., Wilkins, A.L., Mackie, K.L.,  
McFarlane, P.N. 1994. Removal and transformation of resin acids during

secondary treatment at a New Zealand bleached kraft pulp and paper mill. *Water Science and Technology*, 29: 105-121

Zinkl, J. G., Lockhart, W. L., Kenny, S. A., and Ward, F. J. 1991. The effects of cholinesterase inhibiting insecticides on fish. In. *Cholinesterase-Inhibiting Insecticides* (P. Mineau, Ed.). Elsevier, London, pp 151–200.